

Introduction

CATIA 3DEXPERIENCE Electrical 3D Design

Wrqp"eq o rnvkqp"qh"vjku"eqwtug"vjg"uvwfgpv"ujqwnf"jcxg"c"hwmm"wpfgtuvcpfkpi"qh"vjg
hqnnqykpi"vqrkeu<

- / Fghkpg"gngevtkecn"igqogvt{"cpf"dcpcejgu
- /" Fghkpg"eq o rnvvg"jctpguugu"ykvj"uwrrqtvu
- / Fgxnqr"jctpguugu"ykvjkpvjg"eqpvz"qh"c"rtqfwev
- / Fgxnqr"cpf"vknk|g"c"jctpguu"kp"o wvkrng"rtqfwevu
- / Etcvg"hqto dqctfu"ht"mncvvgpkpi"cpf"qrvkok|kpi"c"jctpguu"ht"o cpwhcevwtkpi

Electrical 3D Design

Fghkpkp i "cp" gngevtkeci" jctpguu" tgs wktgu" v y q" uvgru0"" [qw" o wuv" hktuv" fghkpg" v j g" tgs wktgf
eqppgevtu" cpf" eqppgevkqp" r qkpvu0"" Qpeg" { qw" j cxg" v j gug" eqppgevkqpu." { qw" ctg" tgc f { "vq" dg i kp
fghkpkp i "v j g" i gq o gvtke" dwpfng" v j cv" nkpmu" v j g" xctkwu" eqppgevkqp" r qkpvu0"" V j gug" i gq o gvtke

Electrical Harness Design

Kp"vjku"ugevkqp."{qw"yknn"nqqm"cv"fgxgnqrkpi"c"uk o rng"ukping"dtcpej"jctpguu0""Mggr"kp"okpf.
{qw"yknn"dg"wukpi"dqvj"vjg"Gngevtkecn"5F"fgukip"cpf"Gngevtkecn"5F"Rctv"fgukip
yqtm dgpejgu0""Vjgug"vyq"yqtm dgpejgu"yqtm"vqigvjgt"vq"fg hkpg"vjg"jctpguu"cpf"vjg"dw p fngu0

Defining Electrical Branch Geometry

Kp"vjku"hktuv"gzgtekug."{qw"ctg"iqkpi"vq"nqqm"cv"etgcvkpi"c"dcuke"ngnevtkecn"dtcpej"dgvyggp"vyq
eqppgevtu0""Cu"{qw"eqpvkpwg"vtqw"ij"vjku"dqqm."{qw"yknn"hkpf"vjg"jctpguu"cpf"dtcpejgu
dgeqokpi"oqtg"cpf"oqtg"eqo rngz"cu"vjg"qrvkqpu"ctg"eqxgtgf"kp"oqtg"fgvckn0

&UHDWH D QHZ SURGXFW QDP MjG"pgy"(r&fwev"yknn"ugx"cu"DHV V
{qwt"hktuv"jctpguu0"

,I QRW DOUHDG\ VKKH(OHFVZULWFDKO W'R'FWJL"y"cu"zR"U"NE H
vq"dwknf"vjg"ngnevtkecn"jctpguu0"

6HOH Electrical Geometry LFRQ W ELEC060 - Harness IURP WKH
VSHFLILFD "Rjg"Electrical Geometry"ykpfy"cr r gctu0

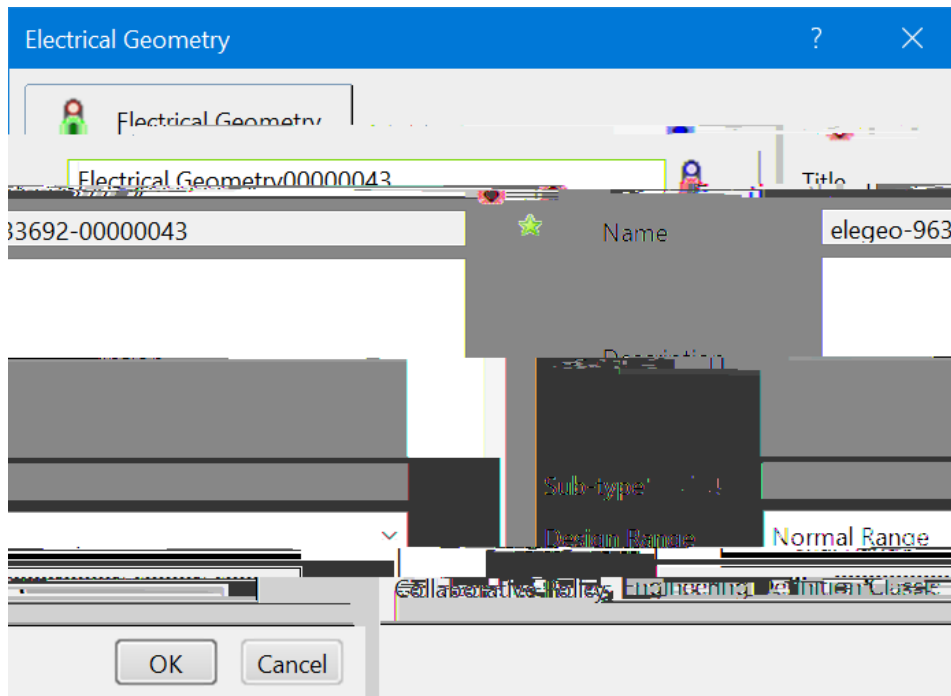

&K D Q J Hltw MVR (/(& (O H F W U L F O G O V K B R j W U r gct"cu
ujqyp0

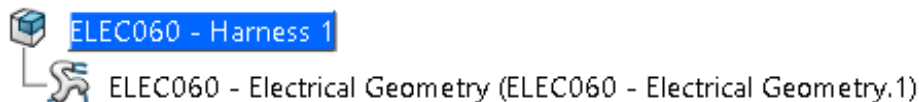

5 LJKW FLEEC010 Electrical Geometry LQ WKH VSHFLILFD MskRQ WUHH D
Existing 3D Part Vjku"yknn"fkurnc{"vjg"Search Selection"ykpfaqy0"

6 HDUFK IRU D ELEC-V Pin Mount Connector GRFXPHQW IURP WKH
Electrical Harness I G L U H F W R y l n \ d g " c " u k o r n g " h q w t " r k p " o q w p k p i " e q p p g e v q t 0

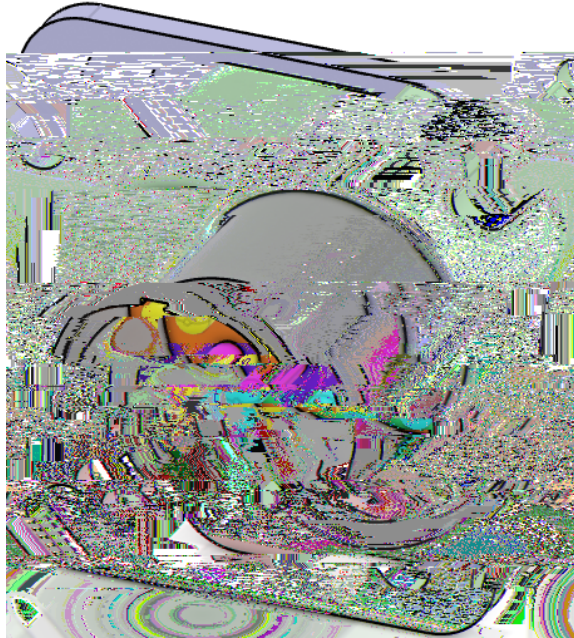

Tg o g o d g t . " { q w " e c p " c n u q " k p u g t v " e q o r q p p v u " h t q o " v j g " e c v c n q i 0

6 HOH Catalog Browser LFRQ IURP WKH ERWWRP Pjg W R O E D U
ugevkqp0"Vjku"yknn"fkurnc{"vjg"Catalog Browser"ykpfaqy0"

6 HDUFK IRU D ELEC- Electrical Catalog WKHQ H [S o n e C o r s W K H
FKDSWHU D Q S i g n I n s e r t C o n n e c t o r K H I D P L v O j q w n f " e r r g e t " c u " u j q y p 0

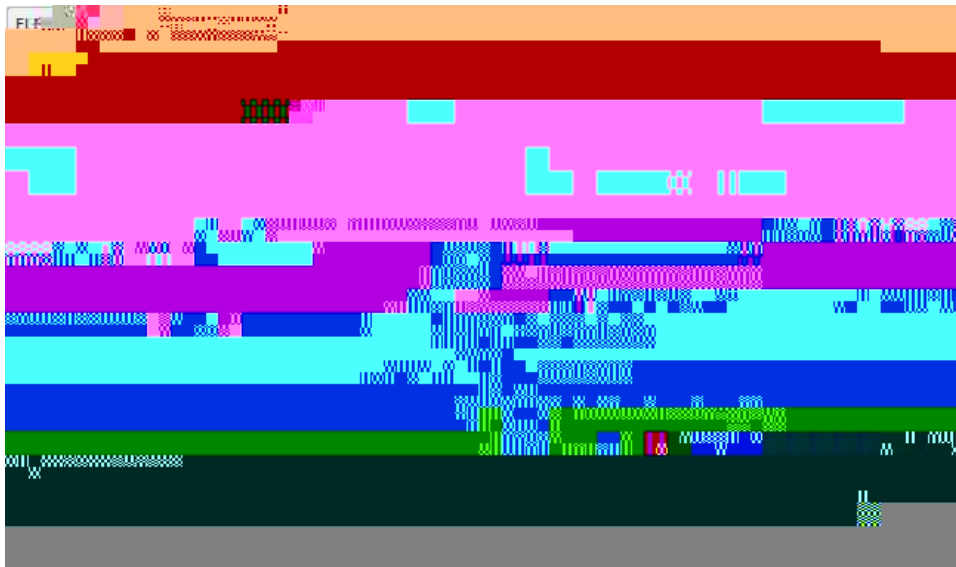

6 HOH ELEC-4 Electrical Geometry EUDQFK LQ WKH WUHH DQG WKH C
ELEC - 4 Pin Connector IURP WKH FDWDORJ R d gvy R y km " Qv t U W L W
eqppgevqt "kp vq "v jg"cuug o dn { "cu" y gmn0

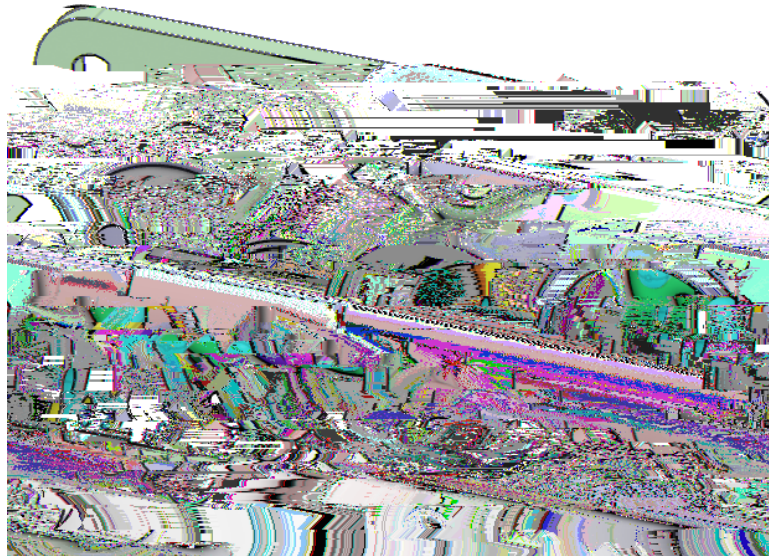

&ORVH WKH FDWDORJ EURZVHU ZKHQ GRQH

'RXEOH VHO ELEC-4 Electrical Geometry EUDQFK WR "D F W M L Y D W H L W
cnnqy " {qw"vq" ocpkrwncvg"v jg"eq o rppgvu" ykv jkp "kv0""

8VLQJ WKH FRPSDVV DRWL R Q W HRUR D D Q I P S D Q S R O D W H W R K U H W F
DSSUR [LPDWH O R F D W L R Q W K R Z G v k t g f . " I w u v " u g r c t c v g " v j g " v y q
rctvu0

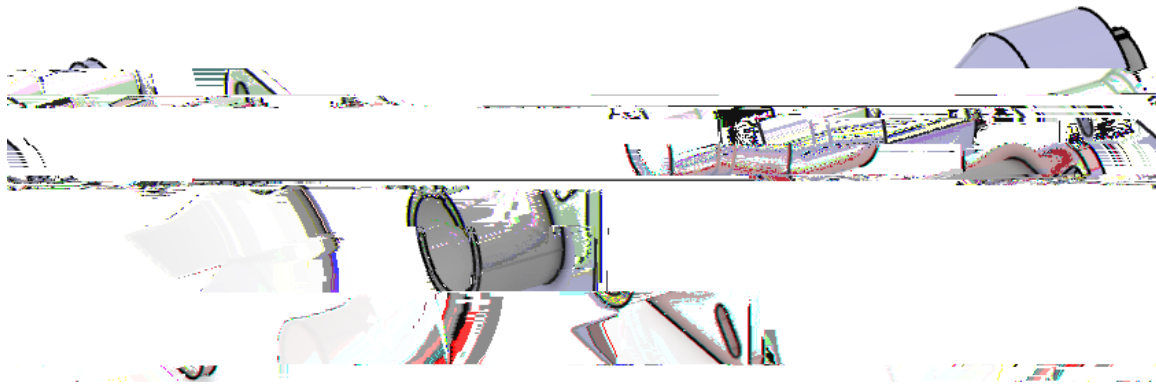

Cv"v jku" rkp v . " {qw"ctg" tgc f { "vq" fghkpg" c" dwp fng" dg v y ggp" v j g" v y q" eqppgevqtu0

6 H O H Electrical Branch Geometry L F i " " " K v " k u " n q e c v g f " w p f g t " v j g " (O H F W U L F D O
* H R P H W U \ " V j g " Electrical Branch Geometry " y k p f q y " c r r g c t u 0

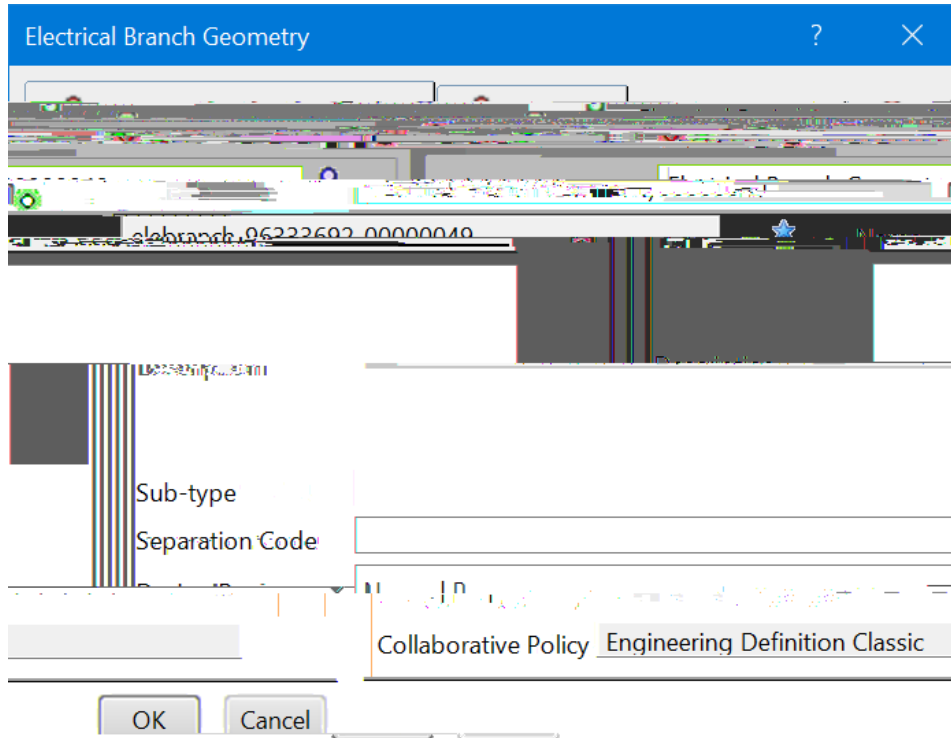

& K D Q J H i t t e W M H R E H (/ (& (O H F W U L F D D Q % U D K Q F K F W H R P H W U \

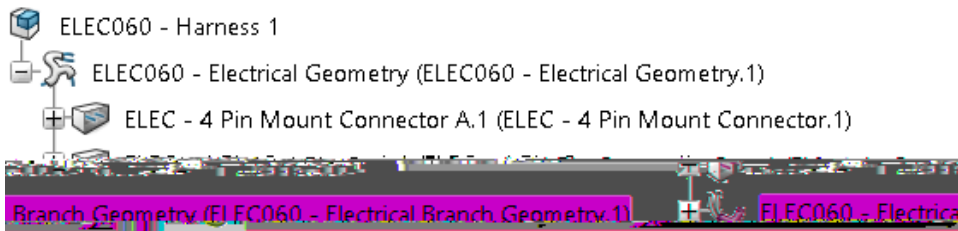

Vjg"Branch Definition" ykpfqy"cnuq"cr rgctu0"

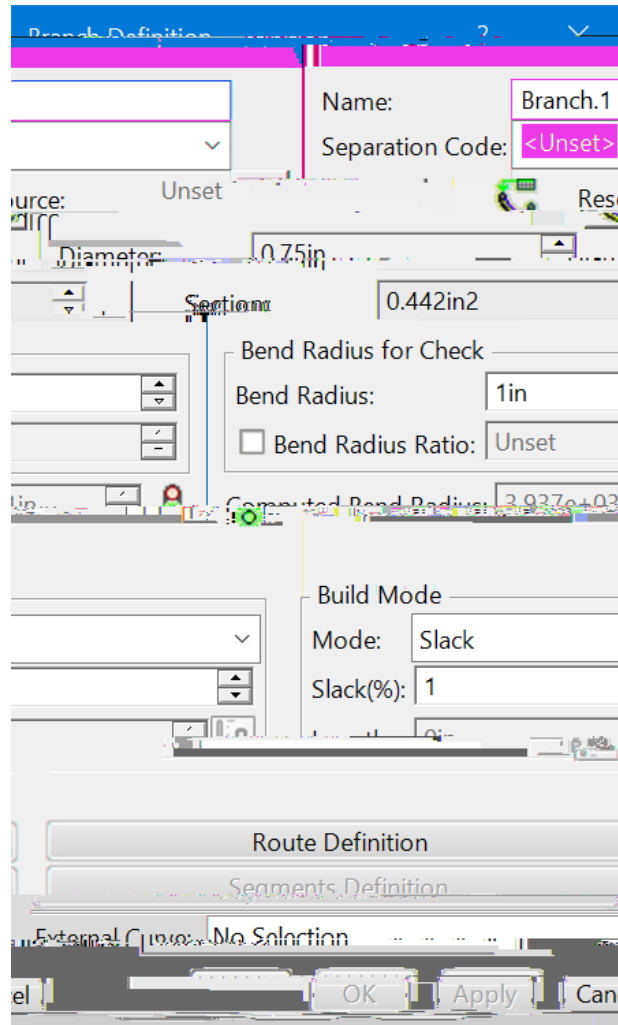

<i>Name</i>	Urgekhhkgu"vjg"pc o g"qh"vjg"dtcpe j
<i>Separation Code</i>	Urgekhhkgu"vjg"ug rctcvkqp"eq fg"xcnwg"hqt"vjg"dtcpe j
<i>Resource</i>	Fkurnc {u"vjg"wpkswg"kf gpvkhkg"ht"vjg"dtcpe j
<i>Diameter</i>	Urgekhhkgu"vjg"qvwukfg"fk c o gvg"qh"vjg"dtcpe j
<i>Section</i>	Urgekhhkgu"vjg"etquu"ugevkqpcn"ctgc"qh"vjg"dtcpe j
<i>Bend Radius</i>	Urgekhhkgu"vjg" o kpk o w o "dgp f"tc fkwu"cnqy gf"ht"vjg"dtcpe j
<i>Bend Radius Ratio</i>	Fghkpgu"vjg"dgp f"tc fkwu"dcug f"qp"vjg"fk c o gvg"qh"vjg"dtcpe j0""C"tcvkq qh"3" yknn"ugv"vjg" <i>Bend Radius</i> vq"vjg"uc o g"uk g"cu"vjg"dtcpe j" <i>Diameter</i> 0

Build Mode

Mode"

<i>Slack</i>	Dtcpejgu"ctg"eq o r wvgf" y kvj "c" okpk o w o "fkuvcepeg."cpf vjgp"c" rgtgepvc i g"qh"uncem"ku"cf f g f"vq"vjg"dtcpej
<i>Length</i>	Dtcpejgu"ctg"c"ugv"ngpi vj ."tgi ct fnguu"qh"vjg"c o qwpv"qh uncem
<i>Bend</i>	ECVKC" yknn"eq o r wvg"vjg" okpk o w o "ngpi vj" rquukdng y jkng"tgur gev kpi "vjg" <i>Bend Radius</i>
<i>Straight Bend</i>	Ugi o gpv"ngpi vj "eqttgurqpfu"vq"vjg"rcvj" fghkpgf"d{ cteu"qh"ektengu"qh"hkzgf"tcfkwu"cpf"uvtcki j v"nkpgu"i qkpi vj tqw i j" r qkpvu0"
<i>Cornered Polyline</i>	Ugi o gpv"ngpi vj "eqttgurqpfu"vq"vjg"ujqtvguv"rcvj fghkpgf"d{"cteu"qh"ektengu"qh"hkzgf"tcfkwu"cpf"nkpgu0 Vjg"ewtxg"fqgu"pqv"i q"vj tqw i j"vjg"r qkpvu."gzegrv"kh"vjg dgpf"tcfkwu"ku"gs wcn"vq" gtq0"Vcpi gpe{"cv"tq wvg"r qkpvu ku"ki pqtgf0
<i>Slack (%)</i>	Fghkpgu"vjg"rgtegpvc i g"qh"uncem"dgv y ggp"eqppgevkqp"r qkpvu0" Cnvj qw i j"2 ' "ku"cnqy g f."vjgtg"pggfu"vq"dg"c"uncem"qh"cv"ngcuv 03 ' "vq"cxqkf"wr fcvg"gttqtu" y kvj" J ctpguu"Hncvvgpkpi "vqqnu0
<i>Length</i>	Fghkpgu"vjg"ngpi vj "qh"vjg"dtcpej" y jgp"kp" <i>Length</i> o qfgl""Vjg ngpi vj" o wuv"dg"cu"nqpi ."qt"nqpi gt"vjcp"vjg"fkuvcepeg"dgv y ggp vjg"v y q"eqppgevkqp"r qkpvu0
<i>Route Definition"</i>	Fghkpgu"vjg"dtcpej"tq wvg
<i>Segments Definition</i>	Cnnqy u" hqt"vjg"dtcpej"vq"u y cr"ukfgu"qh"c"uwthceg"vjcv"ku"cvcejg f"vq vjg"dtcpej
<i>External Curve</i>	Cnnqy u"ugngevkqp"qh"c"ewtxg"vq" fghkpg"vjg"dtcpej"tq wvg
Ocp{"qh"vjgug"rctc o gvgtu" y knn"dg"vguvgf"hwvtjgt"qpeg"vjg"tq wvg"ku" fghkpgf0"	
& KDQJ Name W KMR + DUQH V "W jku" y % U D Q F K	
8 Q O H V V D O U H D G Dimension W R K D Q U Q I W K E H vjg"Section" y knn cwwq o cvkecn{"ejcpi g"vq"203 ; 8kp40""Vjku"ku"fwg"vq"vjg"v y q"hgknfu"dgkpi"eq o r wvgf"dcugf"qp gcej"qvjgt0"	
& KDQJ Bend Radius W R V { L Q {"qwt"dgpf"tcfkwu" y knn"dg"gs wcn"vq"qt"i tgcvgt vjcp"vjg"fk o gvgt0"Kh" {qw"ugv"vjg"dgpf"tcfkwu"u o cnngt"vjcp"vjg"fk o gvgt."ECVKC" y knn"fkurnc { cp"gttqt" o guuci g"cdqvw"vjg"k o rtcevkecnkv {"qh"vjku0"	

& K D Q J **Build Mode** **Slack** D Q G **Slack** S M K I F H Q W D V j k H y k W j R x g " c m
v j g " d t c e j " q r v k p u " f g h k p g f 0 " " P q y " v q " i g p g t c v g " v j g " d t c e j " x k c " v j g " t q w v g " f g h k p k v k p p 0

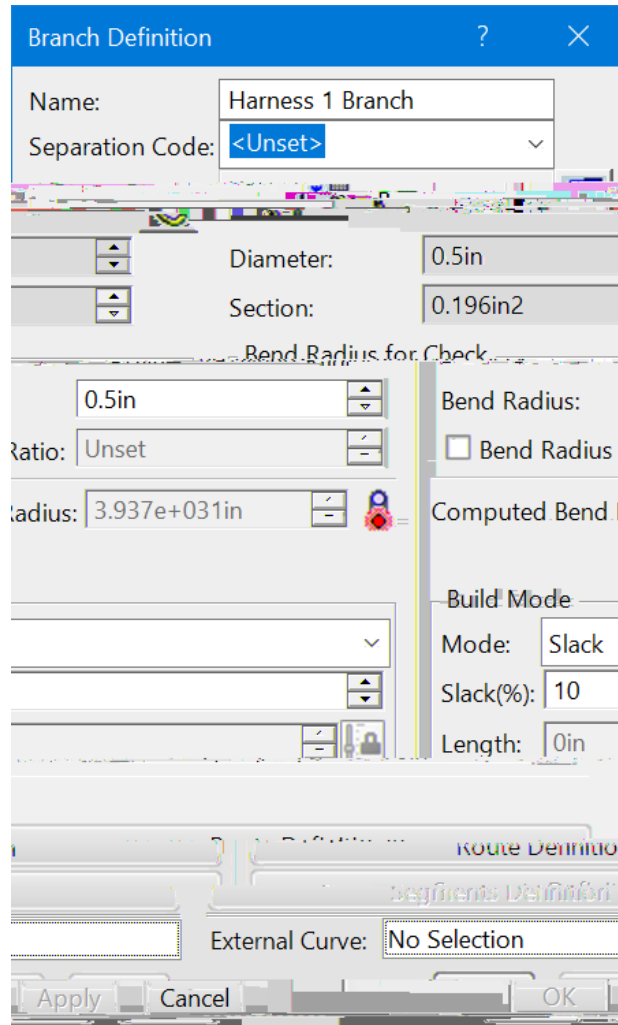

6 H **Route Definition** "V jku" y knn"cnqy" {qw"vq" fghkpg"vjg"tqwvg"hqt"vjg"dwpfng0""V jg"Route
 Definition" ykpfqy" y knn" fku rnc {0""Vcmg" c" swkem"nqqm"cv"vjg"xctkqwu"qr vkqpu"kp"vjg"Route
 Definition" ykpfqy0"

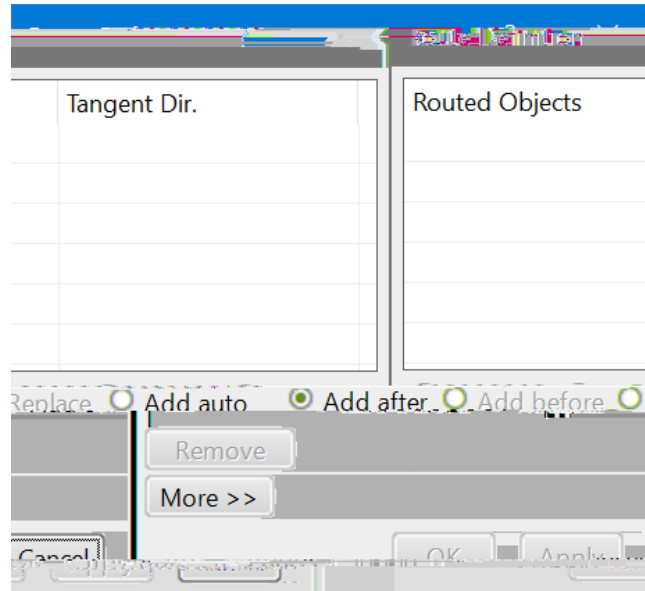

- Routed Objects / Tangent Dir.* Fku rnc {u"vjg"qdlgevu"cpf" rkpvu" hqt"vjg"tqwvg" fghkpkvkqp
- Add after* Cf fu" rkpvu"cpf" eqppgevkqp" rkpvu" chvgt"vjg"ugngevg f rkp v
- Add before* Cf fu" rkpvu"cpf" eqppgevkqp" rkpvu" dghqtg"vjg"ugngevg f rkp v
- Replace* Tgrncegu"vjg"ugngevgf" rkp v" y kvj" cpqv jgt"ugngevkqp
- Replace* Tgrncegu"vjg"ugngevgf" rkp v" y kvj" cpqv jgt"ugngevkqp
- Add auto* Cwvq o cvkecm { "qt fgtu"vjg"tqwvg"ugngevkqpu"dcugf"qp vjgkt"v { rg

D{"ugngevkpi "v j g"More>> dwvvp."{qw"i g v" c" h g y" c f f k v k q p c n" q r v k q p u 0"

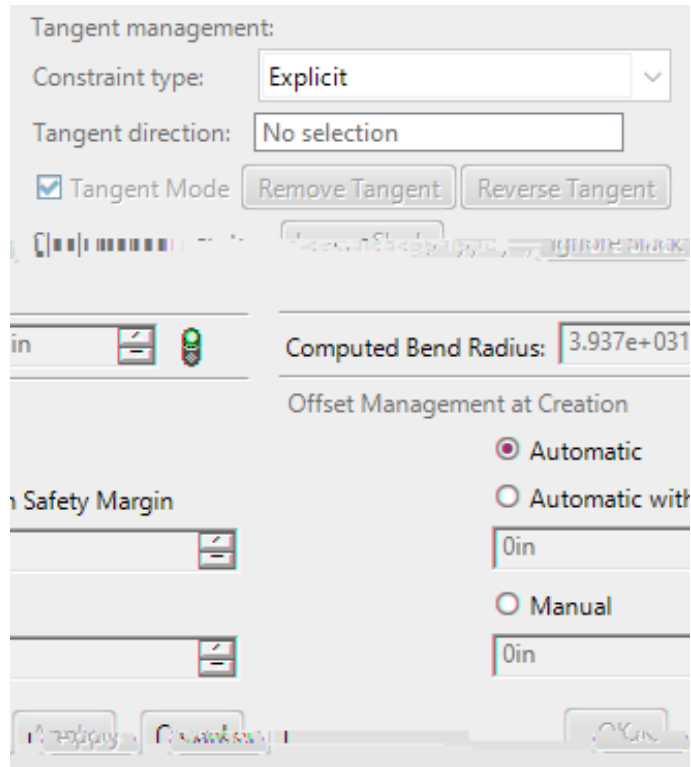

Tangent management

<i>Constraint type</i>	Fghkpgu"v j g"v { r g" q h" v c p i g p e { " v q" d g" f g h k p g f
<i>Explicit</i>	Vc p i g p e { " k u" f g h k p g f" x k c" c" o c p w c n" x g e v q t" f g h k p k v k q p 0" Vc p i g p e { " f g h k p k v k q p" k u" f g h k p g f" v j t q w i j" c" t k i j v" e n k e m" k p v j g" <i>Tangent Direction</i> " h k g n f 0
<i>From curve</i>	Vc p i g p e { " k u" f g h k p g f" h t q o" c" e w t x g" q t" n k p g" u g n g e v k q p 0" Y j g p" <i>From curve</i> " k u" u g n g e v g f. " v j g" <i>Tangent direction</i> e j c p i g u" v q" <i>Element</i> 0"

Slack management K i p q t g u" q t" t g o q x g u" u n c e m" d g v y g g p" r q k p v u

Offset Management at Creation

<i>Automatic</i>	Nc { u" v j g" d w p f n g" q p" v j g" u w t h c e g
<i>Automatic with...</i>	Nc { u" v j g" d w p f n g" q p" v j g" u w t h c e g" y k v j" c p" c f f k v k q p c n" q h h u g v" q h" v j g u c h g v { " o c t i k p" f k u v c p e g
<i>Manual</i>	C n n q y u" { q w" v q" u r g e k h { " c" u r g e k h k e" f k u v c p e g" h q t" v j g" d w p f n g" v q g z k u v" q h h" v j g" u w t h c e g

P q y" { q w" c t g" t g c f { " v q" f g h k p g" v j g" t q w v g 0"

6 HOHFW WKH 3 LQ "PRXQW & RQQHFW R" { "cffgf"vq"vjg
Route Definition" ykpfaqy."cu" ygm"cu"vjg"ugi o gpv"eqppgevkqp" rqkp"ku"cwvq o cvkecnn {"fghkpgf0



Cp{vk o g" {qw"ugnev"cp"gngevtkecn" fgxkeg" ykvj "c"ugi o gpv"eqppgevkqp" rqkpv."vjg"eqppgevkqp
r qkp" y km"cwvq o cvkecnn {"dg"ugnevfg"cpf"vjg"vcp i gpv" fktgevkqp" y km"cwvq o cvkecnn {"dg" fghkpg f
kp"vjg"Initial Condition fktgevkqp" fghkpgf"kp"vjg"ugi o gpv"eqppgevkqp" r qkp"vøu" rnceg o gpv
eqpvtckpvu0"

6 HOHFW WKH 3 LQ "PRXQW & RQQHFW R" { "cffgf"vq"vjg"tqwgf"qdlgevu0"
Pqkeg"vjg"dwpfng"ku"pqy" rtgugpv0"

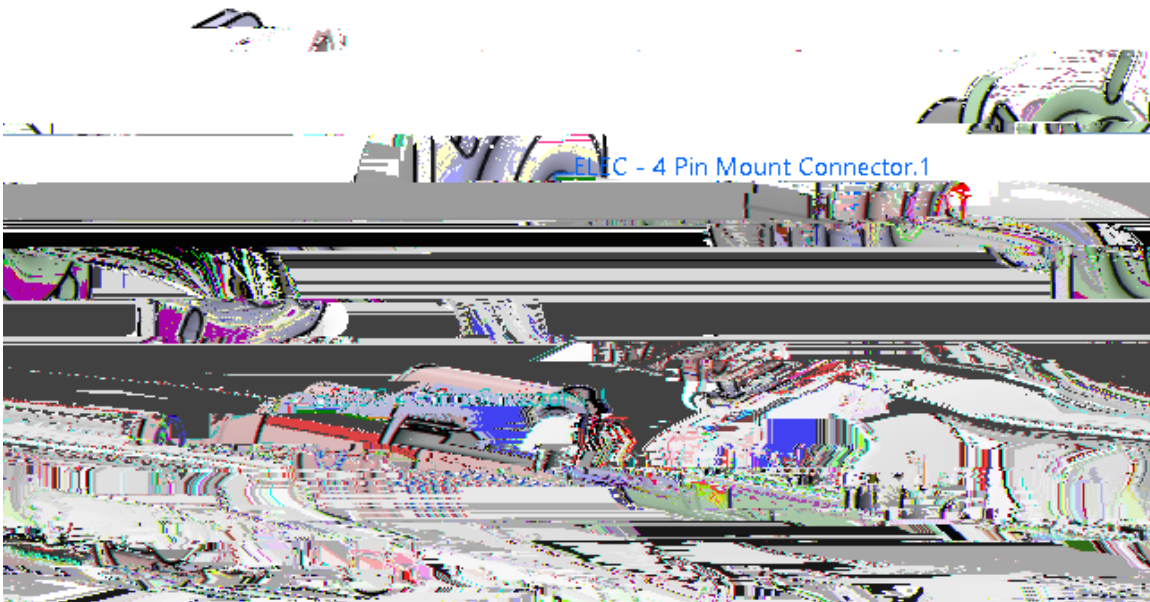

Note: The physical shape of the branch may vary based on the position of the two connectors."

6 H O O K F W R R ~~W~~ ~~K~~ ~~H~~ ~~D~~ ~~e~~ ~~f~~ ~~i~~ ~~n~~ ~~i~~ ~~t~~ ~~i~~ ~~o~~ ~~n~~ ~~"~~ ~~Z~~ ~~L~~ ~~Q~~ ~~G~~ ~~V~~ ~~R~~ ~~Z~~ ~~"~~ ~~y~~ ~~k~~ ~~n~~ ~~"~~ ~~v~~ ~~c~~ ~~m~~ ~~g~~ ~~"~~ ~~{~~ ~~q~~ ~~w~~ ~~"~~ ~~d~~ ~~c~~ ~~e~~ ~~m~~ ~~"~~ ~~v~~ ~~q~~ ~~"~~ ~~v~~ ~~j~~ ~~g~~ ~~"~~ ~~B~~ ~~r~~ ~~a~~ ~~n~~ ~~c~~ ~~h~~ ~~"~~ ~~D~~ ~~e~~ ~~f~~ ~~i~~ ~~n~~ ~~i~~ ~~t~~ ~~i~~ ~~o~~ ~~n~~ ~~"~~

6 H O O K F W R R ~~W~~ ~~K~~ ~~H~~ ~~D~~ ~~e~~ ~~f~~ ~~i~~ ~~n~~ ~~i~~ ~~t~~ ~~i~~ ~~o~~ ~~n~~ ~~"~~ ~~Z~~ ~~L~~ ~~Q~~ ~~G~~ ~~V~~ ~~R~~ ~~Z~~ ~~"~~ ~~y~~ ~~k~~ ~~n~~ ~~"~~ ~~v~~ ~~c~~ ~~m~~ ~~g~~ ~~"~~ ~~{~~ ~~q~~ ~~w~~ ~~"~~ ~~d~~ ~~c~~ ~~e~~ ~~m~~ ~~"~~ ~~v~~ ~~q~~ ~~"~~ ~~v~~ ~~j~~ ~~g~~ ~~"~~ ~~B~~ ~~r~~ ~~a~~ ~~n~~ ~~c~~ ~~h~~ ~~"~~ ~~D~~ ~~e~~ ~~f~~ ~~i~~ ~~n~~ ~~i~~ ~~t~~ ~~i~~ ~~o~~ ~~n~~ ~~"~~ ~~P~~ ~~q~~ ~~v~~ ~~k~~ ~~e~~ ~~g~~ ~~"~~ ~~v~~ ~~j~~ ~~c~~ ~~v~~ ~~"~~ ~~{~~ ~~q~~ ~~w~~ ~~"~~ ~~c~~ ~~t~~ ~~g~~ ~~"~~ ~~u~~ ~~v~~ ~~k~~ ~~n~~ ~~"~~ ~~k~~ ~~p~~ ~~"~~ ~~v~~ ~~j~~ ~~g~~ ~~"~~ ~~G~~ ~~n~~ ~~g~~ ~~e~~ ~~v~~ ~~t~~ ~~k~~ ~~e~~ ~~c~~ ~~n~~ ~~"~~ ~~5~~ ~~F~~ ~~"~~ ~~R~~ ~~c~~ ~~t~~ ~~v~~ ~~"~~ ~~F~~ ~~g~~ ~~u~~ ~~k~~ ~~i~~ ~~p~~ ~~"~~ ~~y~~ ~~q~~ ~~t~~ ~~m~~ ~~d~~ ~~g~~ ~~p~~ ~~e~~ ~~j~~ ~~"~~

6 H O H ~~E~~ ~~X~~ ~~I~~ ~~T~~ ~~"~~ ~~V~~ ~~J~~ ~~K~~ ~~"~~ ~~y~~ ~~k~~ ~~n~~ ~~"~~ ~~v~~ ~~c~~ ~~m~~ ~~g~~ ~~"~~ ~~{~~ ~~q~~ ~~w~~ ~~"~~ ~~d~~ ~~c~~ ~~e~~ ~~m~~ ~~"~~ ~~v~~ ~~q~~ ~~"~~ ~~v~~ ~~j~~ ~~g~~ ~~"~~ ~~G~~ ~~n~~ ~~g~~ ~~e~~ ~~v~~ ~~t~~ ~~k~~ ~~e~~ ~~c~~ ~~n~~ ~~"~~ ~~5~~ ~~F~~ ~~"~~ ~~F~~ ~~g~~ ~~u~~ ~~k~~ ~~i~~ ~~p~~ ~~"~~ ~~y~~ ~~q~~ ~~t~~ ~~m~~ ~~d~~ ~~g~~ ~~p~~ ~~e~~ ~~j~~ ~~"~~

Pqvkeg"cv"vqqndct"er r gctu"kp"vjg"fkurnc{"cu"y gmn0



\$ X W R 5 R X W L Q J 0 R G H fkurnc{"u"vjg"ugngev"dtcpej"nqecvkqpu"qp"vjg"hn{"hqt
tqwvkpi"vjg"dtcpej0



5 R X W H R Q % U D Q F K 3 R L Q W j"dtcpej"rqkp"



5 H P R Y D O 0 R G H Tgoqxgu"dtcpej"rqkpvu



& U H D W L R Q 0 R G H fkurnc{"u"vjg"etgcvkqp"qrvkqpu



\$ G G 6 W D Q G D U G % U D Q F K 3 R L Q W j"dtcpej"rqkp"vq"cp
gzkuvkpi"dtcpej



\$ G G \$ V V R F L D W L Y H % U D Q F K 3 R L Q W j"dtcpej"rqkp"vq"cp
gzkuvkpi"dtcpej



\$ G G 3 U R W H F W L Y H & R Y L U Q O g"eqxgtkpi"vq"c"dtcpej



6 S O L W % U D Q F K Urnkvu"cp"gzkuvkpi"dtcpej



7 U D Q V I R U P 0 R G H fkurnc{"u"vjg"vtcpuhqt o"qrvkqpu



7 U D Q V O D W H % U D Q F K tcpuvcgu"c"dtcpej



' H W D L O H G 3 U R I L O H 0 P D D J H R H Q W j"dtcpej

& K D Q J ~~DianWen~~ H W R Slack WMR D ~~BeG~~ ~~RndK~~ H W R ""Pqy"{"qw"ctg
tgef{"vq"tqwvg"vjg"dtcpej0""

0RYH \RXU PRXVH RYHU WKH 3LQ 0R XIQFH & RVQQRH & WRFUWD
WKDW DSRH DUFH D \HOORZ VSKHUH DSSHDUV DW WKH FR

\$Q\WLPH \RX VHOHFW D VHJPHQW FRQQHFWRU & SWRQVW
VHOHFWHG DQG WKH WDQJHQW GEULFH & WLFH & DZL
GLUHFWLRQ GHILQH LQ WKH VHJPHQW UHFRUGV
6HOHFW WKH VHJPHQW FRQQHFWRU & SWRQVW
GHILQH LQ WKH URXWHG REMHFWV 1RWLFH WKH EXQG

Note: The physical shape of the branch may vary based on the position of the two connectors.

6HOHFW LQKHS & BQFK LV FRPSOHWHG

6HOHFWLWKRQ 7KLV ZLOO WDNH \RX EDFN WR WKH (OHFW
DQG DFWLYDWH WKH HOHFWULFDO JHRPHWU\ EUDQFK

6DYH \RXU KDUQHVVWV & ZLWK 2SWLRQV ZRXOG EH DRJRG RSW
EXQGOHV /HDYH \RXU KDUQHVVWV & ZLWK 2SWLRQV ZLOO EH XVH

Defining Multi-Branches

Cnvjqwi j "ukping" dtcpejgu"ctg"xgt{"wughwn" hqt"uk o rng" i gq o gvtke" dwpfngu." {qw" y knn" qhvgp" hkp f vjcv" {qw" ctg" pqv" cdng" vq" etgcvg" vjg" pgeguuct {"dwpfngu" y kvj" lwuv" c" ukping" dtcpej0" "Vjg" o quv eq o o qp" v {rg" qh" dwpfng" wugf. "gxgp" hqt" c" uk o rng" uvtcki jv" i gq o gvtke" dwpfng. "ku" c" o wnvk/ dtcpejcdng0"

2 S H Q **ELEC080 - Multi-Branchable** G R F X P [H Q Y M "etgcvg" c" o wnvk/ dtcpejcdng fqw o gpv" qh" c" uk o rng" jctpguu" qh" vj tgg" eqppgevqtu" kp" c" õ [ö" eqphk i wtcvkqp0"

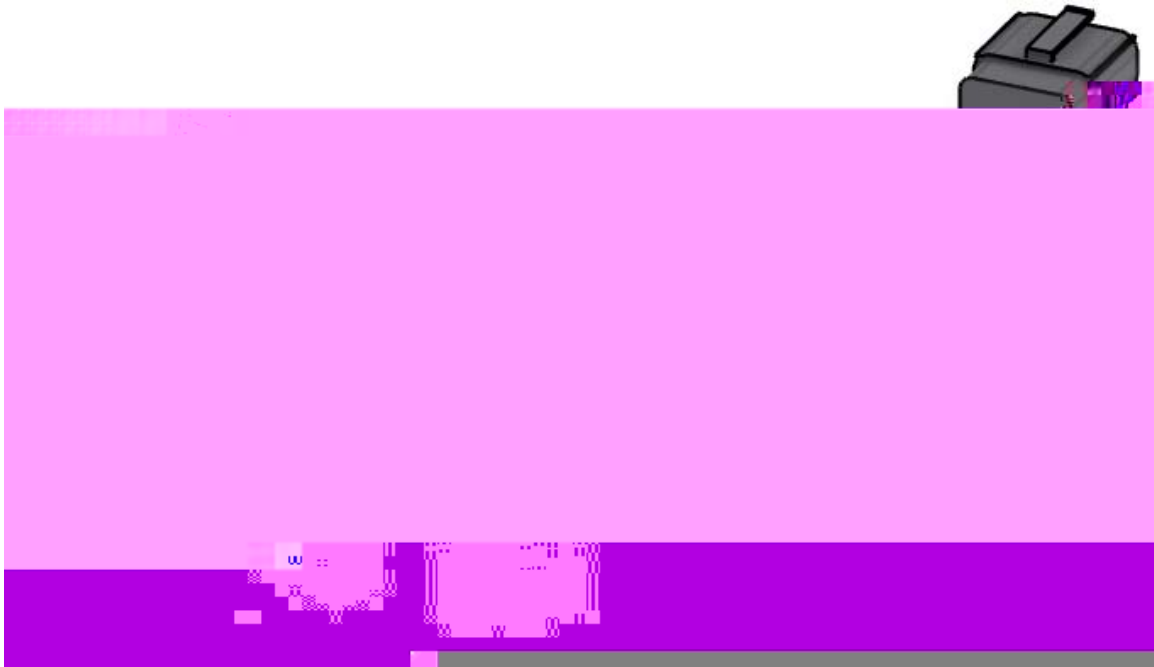

, I Q R W D O U H D G \ V K K I H (O H F W Z L M F F D O W ' R ' F W g h k p k Q " c ' Z R U N E H dtcpej" kpkvkcn {"ku" i qkp i "vq" dg" pq" fkhgtgpv" vj cp" c" ukping" dtcpej0"

6 H O H **Electrical Geometry** L F R Q W K H **ELEC080 - Multi-Branchable** SUR G  Wjg"Electrical Geometry" ykpfqy" crrgctu0"

& K D Q J **Fit** W M V R E H (/ (& (O H F W D I Q F D O K O H F W W i g t c u"ujqyp0"

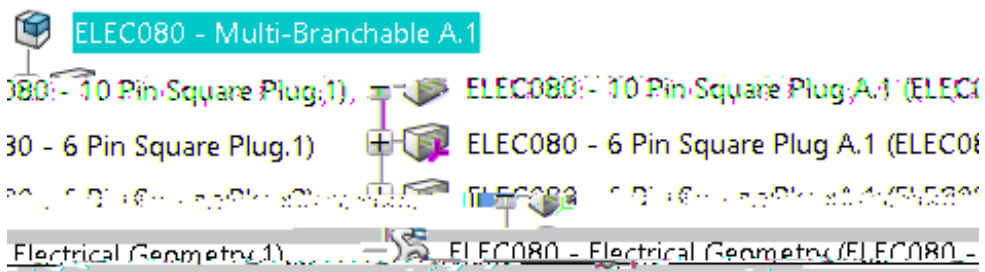

Kp"vjku"ecug." {qw" y knn" o qxg" cnn" qh" vjg" eqppgevqtu" kp" vjg" gngvtkecn" i gq o gvt {"uq" vjg" gpvktg vj kpi" y knn" dg" ugnh" eqpvckpgf0"

'UDJ HDFK RI WKH F ELEC080 - Electrical Geometry "WuKmf"errgct
cu"ujqyp"y jgp" {qw"ctg" hkpku jgf0

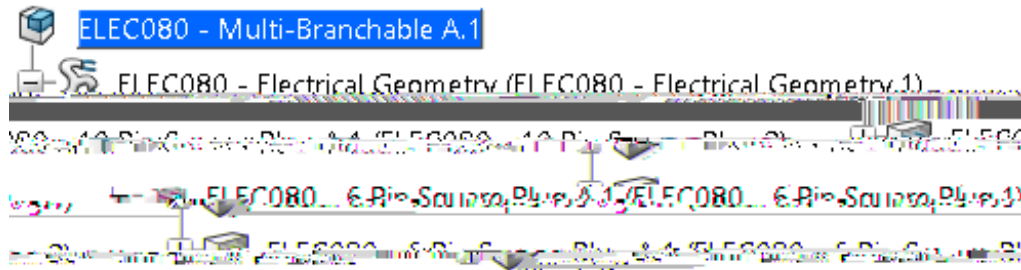

Cv"vjku"rqkp." {qw"ctg"tgcf {"vq" fghkpg"vjg"dtcpej"ugi o gpv0

\$ F W L Y ~~ELEC080 - Electrical Geometry~~ "

6 H O H ~~Electrical Branch Geometry~~ L F " "Vjg"Electrical Branch Geometry
y kpfqy "crrgctu0

. H \ L Q (/ (& (O H F W U L F D O I % U T D K H Q G H V R O M V L Y M n
uvctv" c" dtcpej0"

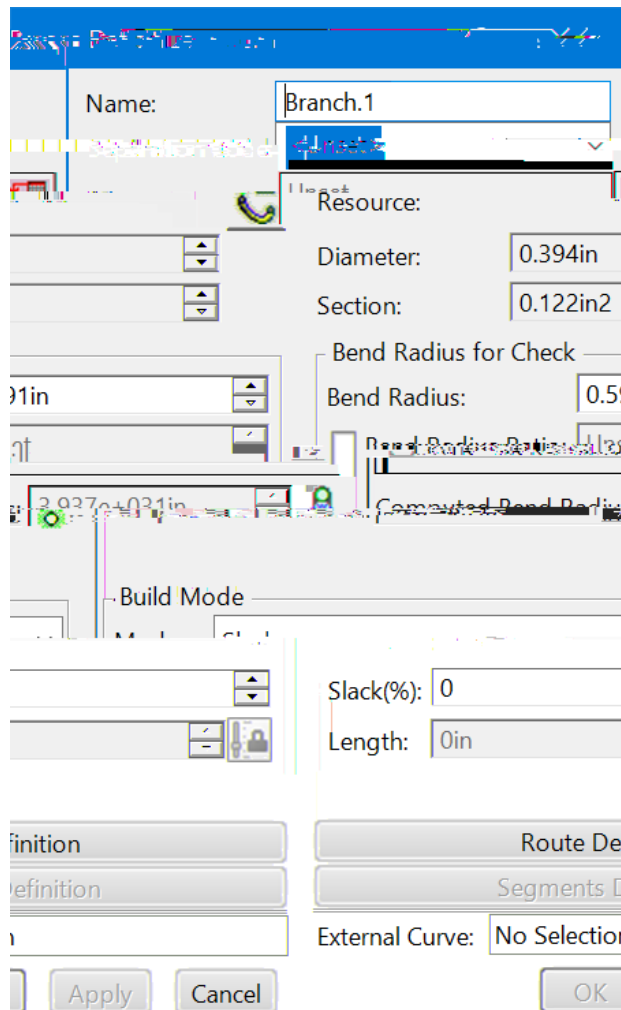

& K D Q J ~~W~~ ~~K~~ H I W K H E U D Q F K W R ~~Q~~ ~~D~~ ~~L~~ ~~O~~ ~~J~~ ~~%~~ ~~U~~ ~~D~~ ~~O~~ ~~F~~ ~~K~~
dtepej" {qw"ctg"iqkpi"vq"etgcvg0"

& K D Q J ~~D~~ ~~i~~ ~~a~~ ~~n~~ ~~e~~ ~~k~~ ~~H~~ ~~W~~ ~~R~~ L Q ~~B~~ ~~e~~ ~~n~~ ~~e~~ ~~K~~ ~~a~~ ~~d~~ ~~i~~ ~~s~~ ~~K~~ ~~M~~ ~~R~~ C i k ~~Q~~ "k"ku"e"iqqf"twng"qh
vjw od"vq" ocmg"uwtg"vjcv" {qwt"dgpf"tcfkwu"ku"nctigt"vjcp" {qwt"dtepej"fk o gvg0"

: L W K W K H

6 HOH Segment Connection Point WH[W WR EHJLQ WKH URXWH DQG WKH
VTXDUH SOXJ DV VKRZQ

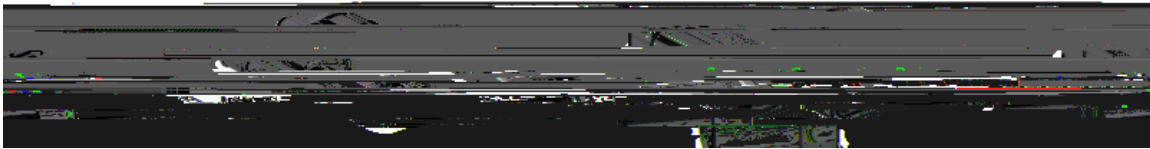

6 HOHFW WKH FRQQHFWRQ SR[LQW FRUW WKH SLQ VTXDUH S



6 H OOKF WPCVKEG"pc y

1

1 – Segment Definition

Vjku"ctgc"cmnqyu" {qw"vq"xkgy"vjg"xctkqwu"ugi o gpvu"kp"c
o wnvk/dtcej

([L W V % U D Q F K 3 R L Q W v j g " d t c p e j " r q k p v " k p " c " d w p f n g



5 H P R Y H % U D Q F K 3 R L Q W v j g " d t c p e j " r q k p v " k p " c " d w p f n g

<i>Name</i>	Urgekhhkgu"vjg"pc o g"qh"vjg"ugi o gpv
<i>Color</i>	Urgekhhkgu"vjg"eqnqt"qh"vjg"ugi o gpv
<i>Resource</i>	Fkurnc { "u"vjg"wpkswg"kf gpvkhgt" hqt"vjg"ugi o gpv
<i>Profile Type</i>	Urgekhhkgu"vjg"ujcrg"qh"vjg"ugi o gpv
<i>Section Parameters</i>	Urgekhhkgu"vjg"uk g"ejctcevgtkuvkeu"qh"vjg"ugi o gpv
<i>Section Area</i>	Urgekhhkgu"vjg"etquu"ugevkqp"ctgc"qh"vjg"ugi o gpv0""Kv"ku nkpmgf"vq"vjg"Section Parameters."uq" o qfkh { kpi "qpg yknn"wr fcvg"vjg"qvjgt
<i>Detailed Profile Management</i>	Cnmq yu" o qtg"kp" fgrvj " o qfkhkecvkqp"qh"vjg" r tqhkngu cnqp i "vjg"ugi o gpv
<i>Extremity Management</i>	
<i>Start point</i>	Fghkpgu"vjg"tcvkq"qh"vjg"ewtxg"vjg"dtcpej" r qkp v"uvctvu
<i>End point</i>	Fghkpgu"vjg"tcvkq"qh"vjg"ewtxg"ngpi vj"vjg"dtcpej" r qkp v gpfu
<i>Visualization Management</i>	
<i>Reframe on Selection</i>	Tghtc o gu"cpf" hkvu"vjg"dwpfng"ugi o gpv"kp"vjg"fkurnc { Cv"vjku"r qkp v." { qw"ctg"tgcf { "vq" fghkpg"vjg"dtcpej" r qkp v0"
	& K D Q J K o l w k w R O L J w E o j x h qh"dnwg"ku"pqv"ko r qtvcpv." { qw"lwuv" ycpv"vq ugg"vjcv"vjg"eqnqt"qh"vjg"dwpfng"ecp"dg"ejcpi g f0"
	Pqy "vq"cff" c" dtcpej " r qkp v0"

6HOHF\$G VDH%UDQFLFBRLOQV\FH \RX VHOHFW WKH LFRQ W
XQWLO \RX VHOHFW WKH EXQGOH SRLQWQLO \RX ZDQW WF

6HOHF&K DQJH 5HIHUHQEFRRZEDS VHOHFW WKH V\PERO QI
VTXDUH SOXJKLV ZLOO VZLWFK VLGHV RI WKH UHIHUHQFI

\$W WKLW SRLQW \RX QHGH WR GHWQWPGQHLQRZ \RQ ZDQ
DVVXPH \RX ZDQW WKH EUDQFK SBLZOWIGRFLQKH DSDHW
FRQQHFWRU

6 H O H ~~EXT~~ WKRHQ ZKHQ "G R Q H"urnkv"vjg"dtcpej"kp"vq"vyq"ugi o gpvu0"
 Pqvkqeg"vjg"ugi o gpvu"ygtg"tgpc o gf"dcem"vq"vjg"fgbcwv"pc o kpi "uejg o g0"

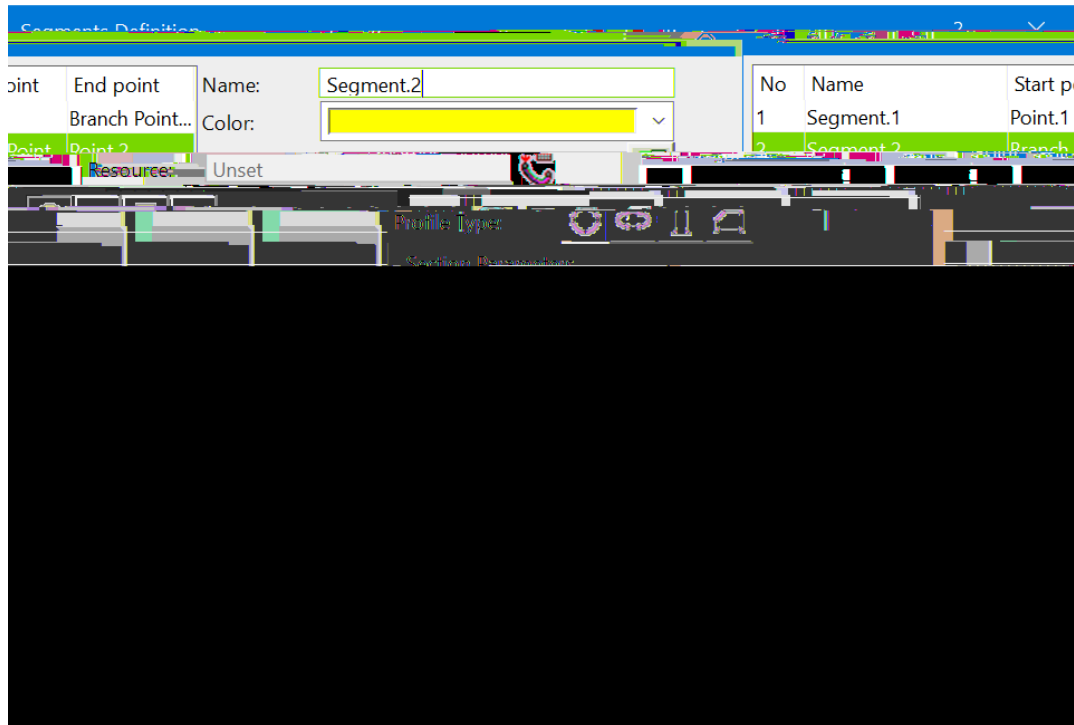

:LWK WKH ILUVW VHJPHQW VHOH ~~Ext~~ W R Q H W K R Z L Q G R Z F
 jgnr" {qw"mggr"vtcem"qh"vjg"xctkqwu"ugi o gpvu0"

Cnuq."pqvkqeg"vjg"uvctv"cpf"gpf"rqkpvu"kp"vjg"Extremity Management0""Vjgug"xcnwgu"ctg"pqy
 ceeguukdng"vq"cf lwuv"vjg"uvctv"cpf"gpf"nqecvkqpu"qh"vjg"ugi o gpvu0"

6 H O S ~~Segment.2~~ D Q G F K D ~~Quarter~~ W K R " [q w Q c { " p g g f " v q " u g n g e v " A p p l y " v q
 igv"vjg"dwpfng"vq"wr fcvg"rtqrgtn{0"



6 H O ~~Ext~~ F W R ~~Segments Definition~~ Z L Q G R Z yknn"jcxg"vjg"pgy"ugi o gpvu" fghkpgf0"

6 H O K F W R B M k H Definition Z L Q G V R k Z y k n n " e t g c v g " v j g " d t c p e j 0 "

6 H O H C l a s s i c B r a n c h D e f i n i t i o n L F I U " " V j k u " y k n n " c n n q y " { q w " v q " e t g c v g " c " p g y d t c p e j " y k v j k p " v j g " g z k u v k p i " d t c p e j " u g v 0 "

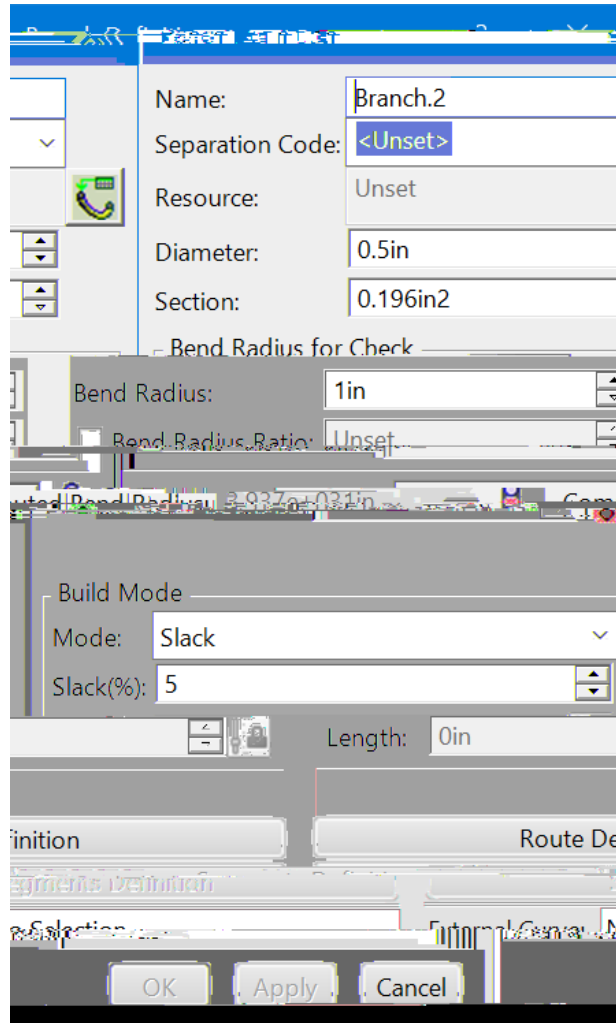

& K D Q J W a n e W R H 6 L G H % M K D H O F D N a m e W R H P q y " Q w " c t g " t g c f { v q " f g h k p g " v j g " t q w v g " h q t " v j g " u k f g " d t c p e j 0 "

6 H O R o u t e D e f i n i t i o n C v " v j k u " r q k p v . " { q w " e c p " u g n g e v " c p { " q h " v j g " e q p p g e v q t u " q t " d t c p e j r q k p v u " v q " u v c t v " v j g " t q w v g 0 " " Y j g p " { q w " u g n g e v " c " d t c p e j " r q k p v . " v j g " u g i o g p v " { q w " u g n g e v " y k n n " j g n r f g v g t o k p g " y j c v " g z v t g o k v { " v j g " d t c p e j " y k n n " c u u q e k c v g " v q 0 "

6 HOHFw WKH \HOORZ P x i G C q h " c f " H d y k u " W d y h p W g " O p f W 0

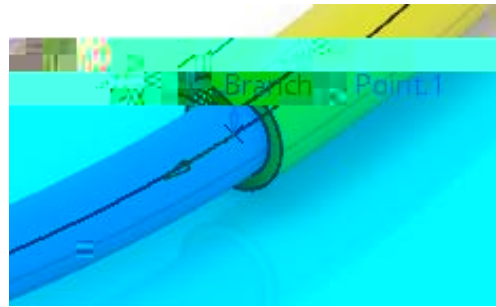

6 HOHFw WKH RWKHU j ku " s n L o f " v g T k p j U H S O X J

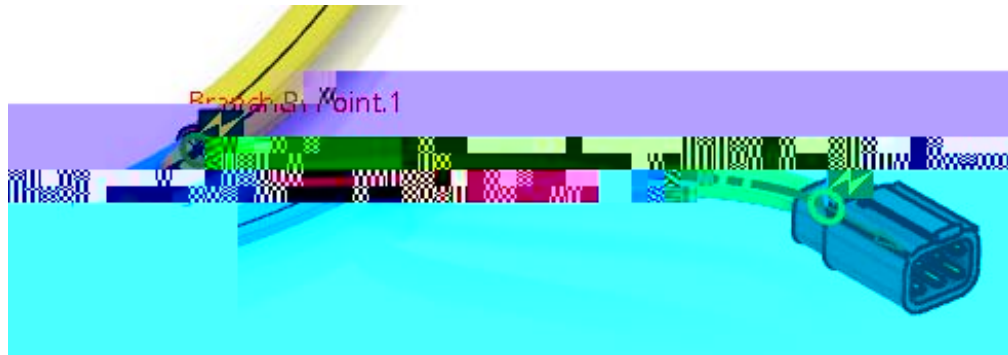

Nqqm"enqugn{ "cv"vjg"ur gekhkecvkqp"vtgg0"

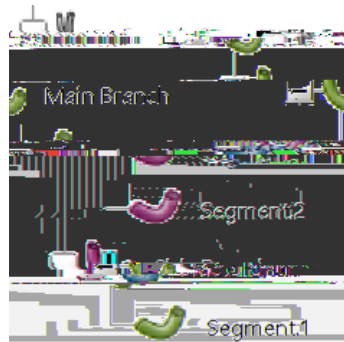

V j g " p g y " d t c p e j " j c u " c p " g z e n c o c v k q p " r q k p v " y k v j " c " { g m n q y " q x c n " c t q w p f " k v " v q " k p f k e c v g " v j c v " v j g
d g p f " t c f k w u " o k i j v " p q v " j c x g " d g g p " t g u r g e v g f 0 " V j k u " k u " p q v " c " e t k v k e c n " g t t q t . " d w v " k v " k u " u q o g v j k p i
{ q w " y k m n " y c p v " v q " y c v e j " h q t " y j g p " { q w " k p u v c n n " v j g " j c t p g u u " k p v q " { q w t " c u u g o d n { 0 " " K h " { q w " h k p f " v j c v

6 H OOKF W R Bm k H Definition Z L Q G V k Z y k n n " j c x g " v j g " p g z v " d t c p e j " f g h k p g f 0 " " K v u j q w n f " c r r g e t " c u " u j q y p 0

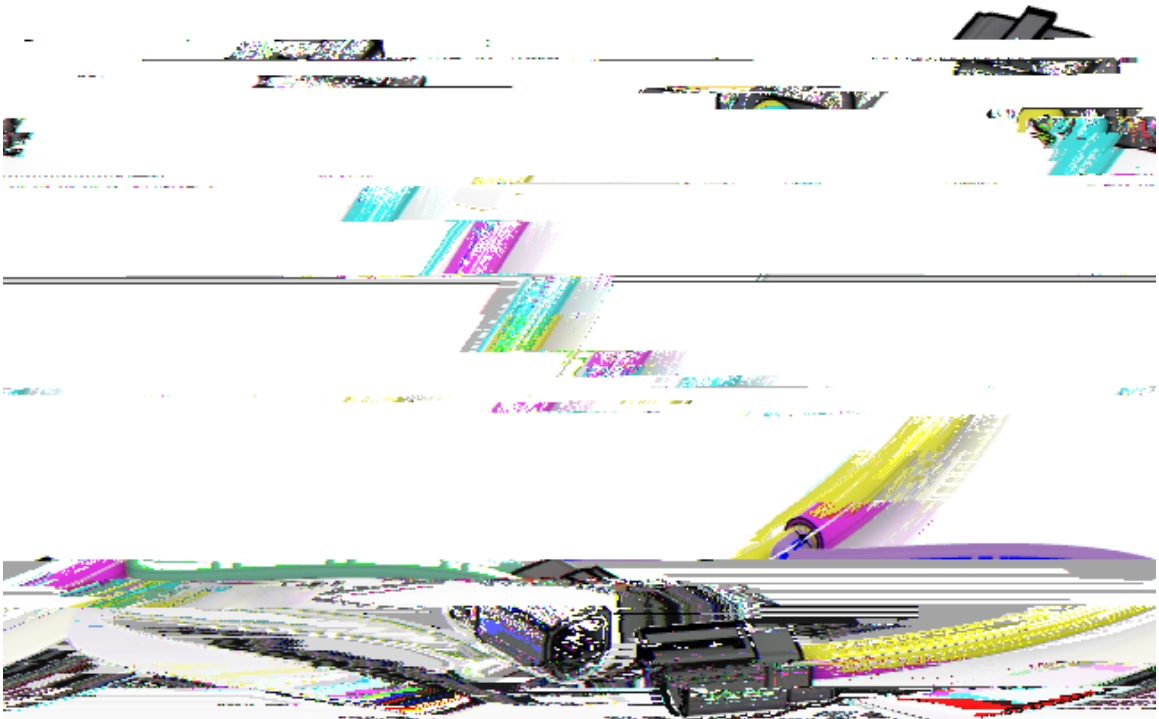

6 H O H E X t W K R I Q W R U H W X U L G D W O R W ' K I W L (Q H Z W U N E H Q F K

' H O H W E L E C 0 8 0 H Electrical Branch Geometry I U R P W K I d w " W k n l e t g d v " v j g u c o g " j c t p g u u " w u k p i " v j g " k o o g t u k x g " q r v k q p u 0

6 H O H E l e c t r i c a l B r a n c h G e o m e t r y L F I  " V j g " E l e c t r i c a l B r a n c h G e o m e t r y y k p f q y " c r r g e t u 0

. H \ L Q (/ (& (O H F W U L F D O I P % U T W K E H Q G H V R O M V U W n u c t v " c " d t c p e j " c p f " v j g " D t c p e j " F g h k p k v k q p " y k p f q y " c r r g e t u 0

6 H O C a r f e n "

6 H O H ~~Wire~~ ~~Branch~~ ~~Definition~~ L F"1 ""Vjg"Branch Properties"y kpfqy
crrgctu0

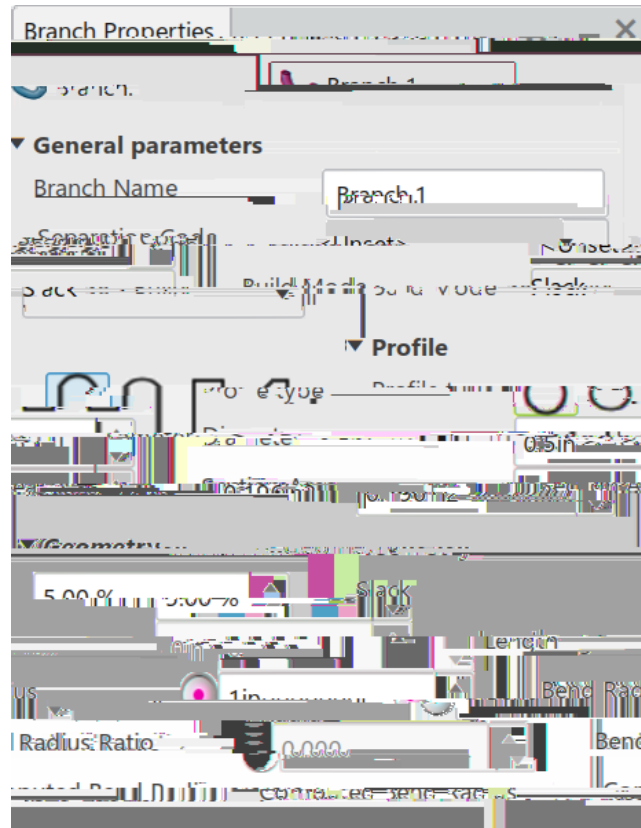

& K D Q J ~~Name~~ W K H E U D Q F K W R ku"0 k"lg"Qjg%ld D Q F k
dtepej" {qw"ctg"iqkpi"vq"etgcvg0"

& K D Q J ~~Diameter~~ W R L Q ~~Bend Radius~~ W K M R C i k p "kv"ku"e"iqqf"twng"qh
vjw od"vq"o cmg"uwtg"vjcv" {qwt"dgpf"tcfkwu"ku"nctigt"vjcp" {qwt"dtepej"fkc ogygt0"

: L W K ~~Build Mode~~ V H ~~Slack~~ R V H ~~Slack~~ & H U F H Q W D J H W R

6HOH Segment Connection Point WH[W WR EHJLQ WKH URXWH DQG WKH
VTXDUH SOXJ DV VKRZQ



6HOHFW WKH FRQQHFWRQ SRLQW WKH URXWH DQG WKH SLQ VTXDUH S

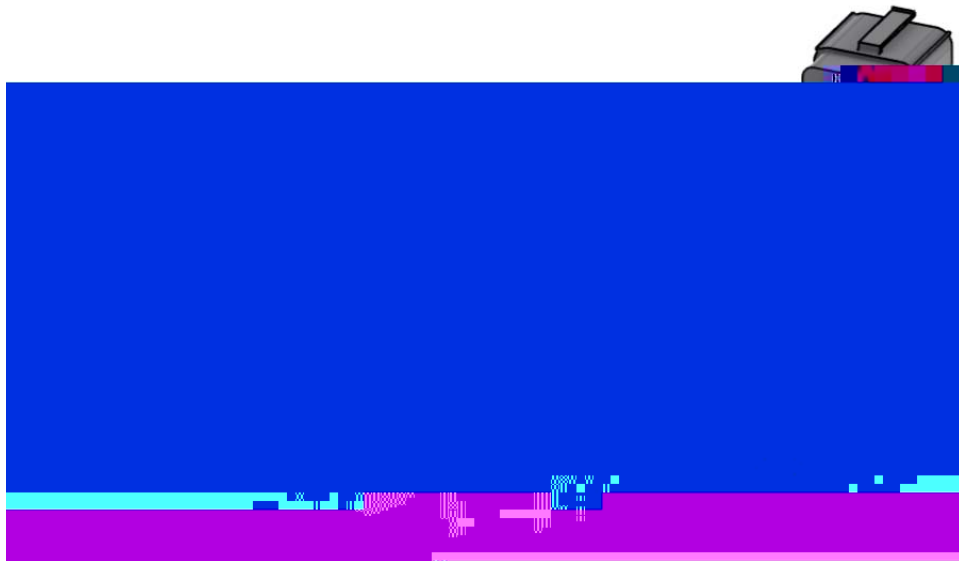

Pqvkqy"vjg"Segment.1"vcd"cr rgctu" ykvj"vjg"Branch Properties" ykpfqy0"

6 H O H Segment.k HW Dvj qwnf" cr rgct"cu"ujqyp0

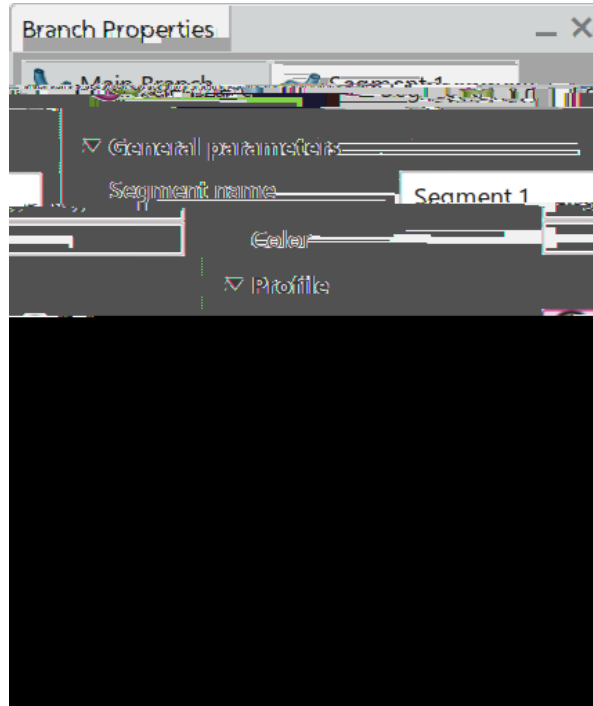

Segment name

Urgekhkgu"vjg"pc o g"qh"vjg"ugi o gpv

Color

Urgekhkgu"vjg"eqnqt"qh"vjg"ugi o gpv

Profile Type

Urgekhkgu"vjg"ujcrg"qh"vjg"ugi o gpv

Diameter

Urgekhkgu"vjg"fkc o gvg"qh"vjg"ugi o gpv

Section Area

Urgekhkgu"vjg"etquu"ugevkqp"ctgc"qh"vjg"ugi o gpv0""Kv"ku
nkpmgf"vq"vjg" *Diameter*

CATIA Electrical Harness Design

8 V H **Change Branch Point Unit** LFRQ LI QHHG HDG StandeR V ZV Lj WFK WR
vgzv"kp"vjg"fkurnc{"ujqwnf"dg"Distance"tcvjgt"vjcp"Ratio0"

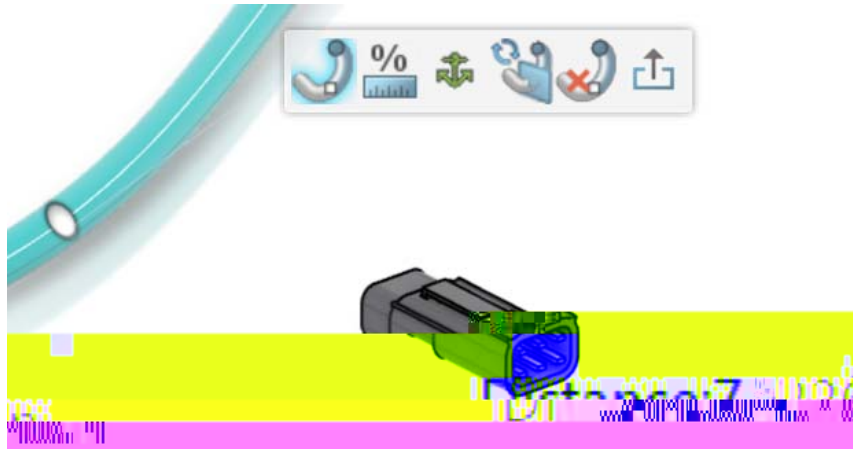

6 H O H **Distance** KW H [W NH \ L Q Enter DVQC G vgl"Q" H F W
8"kpjgu0""Pqy."pq"ocvgt"jqy"nqpi"vjg"igqogvtke"dwpfng"dgeqoguyjgp"{qw"kpucnm"kv."vjg
fkucpeg"vq"vjg"dtgcm"rqpv"yknncnyc{u"dg"8"kpjgu0""Kh}{qw"ygtg"vq"ugv"kv"vq"c"tcvkq."vjgp"vjg
fkucpeg"yqwnf"cfuwv"dcugf"qp"vjg"ngpi"vj"qh"vjg"dwpfng0"

6 H O H ~~EXT~~ WKRIQ ZKHQ "GRQ" "urnkv"vjg"dtcpej"kp"vq"vyq"ugi o gpvu0"
Pqvkeg"vjg"ugi o gpvu"ygtg"tgpc o gf"dcem"vq"vjg" fghcwnv"pc o kpi "ue jg o g0"

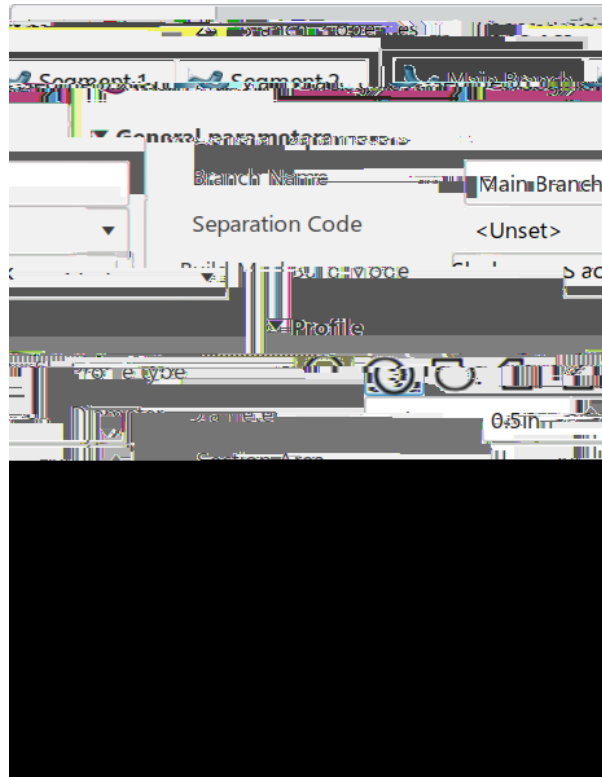

6 ZLWFKSWP ~~WKH~~ KWDE LQ WKH ZLQGRZ ~~Color~~ DQG FKHQ ~~WKH~~ WKH
jgnr" {qw"mggr"vtcem"qh"vjg"xctkqwu"ugi o gpvu0"

Cnuq."pqvkeg"vjg"uvctv"cpf"gpf"rqkpvu"kp"vjg"Extremity Management0""Vjgug"xcnwgu"ctg"pqy
ceeguukdng"vq"cf lwuv"vjg"uvctv"cpf"gpf"nqecvkqpu"qh"vjg"ugi o gpvu0"

6 H O H ~~Segment~~ KWDE DQG ~~Diagram~~ HW WKH" [qv"Qc {"pggf"vq"ugngev
vjg" 7 D"eg {"vq"igv"vjg"dwpfng"vq"wr fcvg"rtqr gtn{0"

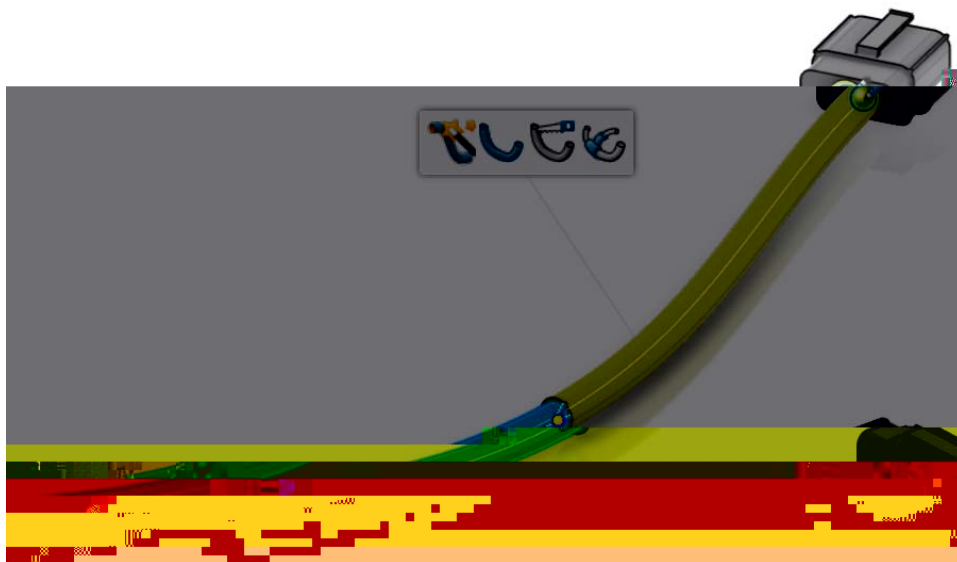

6 HOH Start New Branch LFRQ IURP W I"VWR R Q E D l w "vq"etgcvg
c"pgy"dtepej" ykvj kp"vjg"gzkuvkpi"dtepej"ugv0"

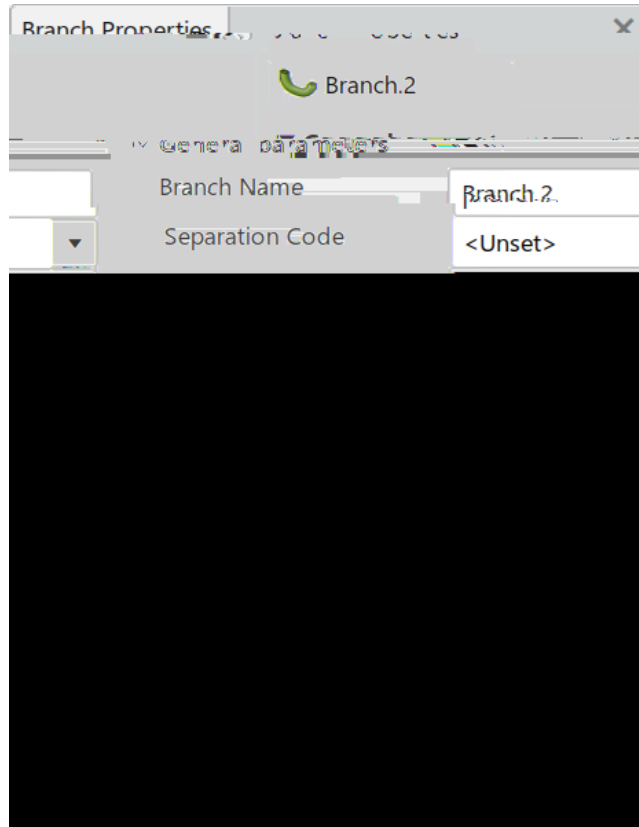

& KDQJ Name WKR 6 LGH %UKDHOFD Name WKR Pqly Qw"ctg"tgcf {
vq" fghkpg"vjg"tqwvg" hqt"vjg"ukfg"dtepej0"

6 HOHFW WKH \HOORZ P XIG G QH C F H U ku W dy pl qp W j g D w p f W 0"

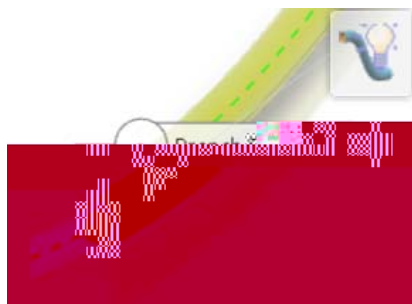

6HOHFW WKH RWKHU jku" ynd"Of"vvg"tkpju H SOXJ

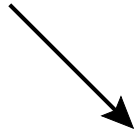

Pqvkeg"vjg"vcpigpe{"fqgupøv"nqqm"tki jv0

6HOHFW WKH EUDQFK SRLQW Vg"Kunfc"Ujqwvf"DrvgcVckulqz p DERYH



6HOHFW **Tangency Mode** LFRQ LQ WKH WRROEDU D VHOHFW WKH
ujqwnf"crrgct"cu"ujqyp0

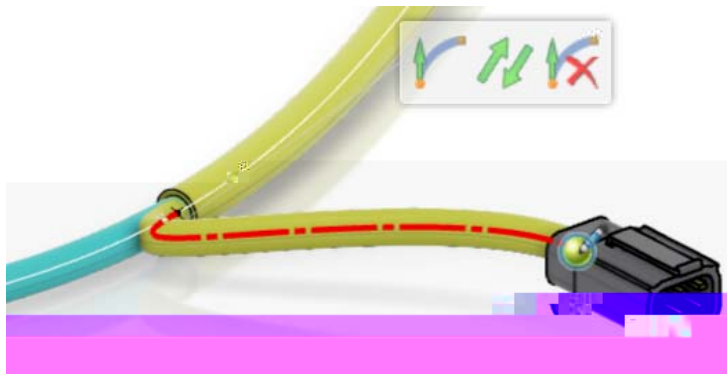

Nqqm"enqugn{"cv"vjg"ur gekhkecvkqp"vtgg0"

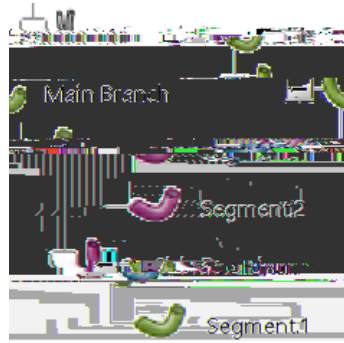

Vjg"pgy"dtcepej"jcu"cp"gzenc o cvkqp"rqkpv"ykvj" c" { gnnqy "qxcn"ctqwpf"kv"vq"kp fkecvg"vjcv"vjg
 dgpf"tcfkwu"oki jv"pqv"jcxg"dggp"tgur gevgf0"Vjku"ku"pqv" c"etkvecn"gttqt."dwv"kv"ku"uq o gv jkpi
 {qw"ykmn"ycpv"vq"ycvej"hqt"y jgp" {qw"kpucnn"vjg"jctpguu"kpqv" {qwt"cuug o dn{0"Kh" {qw"hkp f"vjcv
 {qw"uvknn"jcxg"tcfkwu"kuuwgu"cv"kpucnn"cvkqp."vjgp" {qw" oc { "pggf"vq"nqqm"cv"cf lwuvkpi"vjg"dtcepej
 rqkpv"qt"cffkpi"cffkvkqpcn"uncem0"

6HOH Segment.1 HWDE DQG FORVH \RXU GRFXPHQW

6HOHFW LQ WKH GLVSOD\VWV RY knn J & g vjg Qz v W de j W k p f 0 E v U D Q F K
 ujqwnf"crrgct"cu"ujqyp0

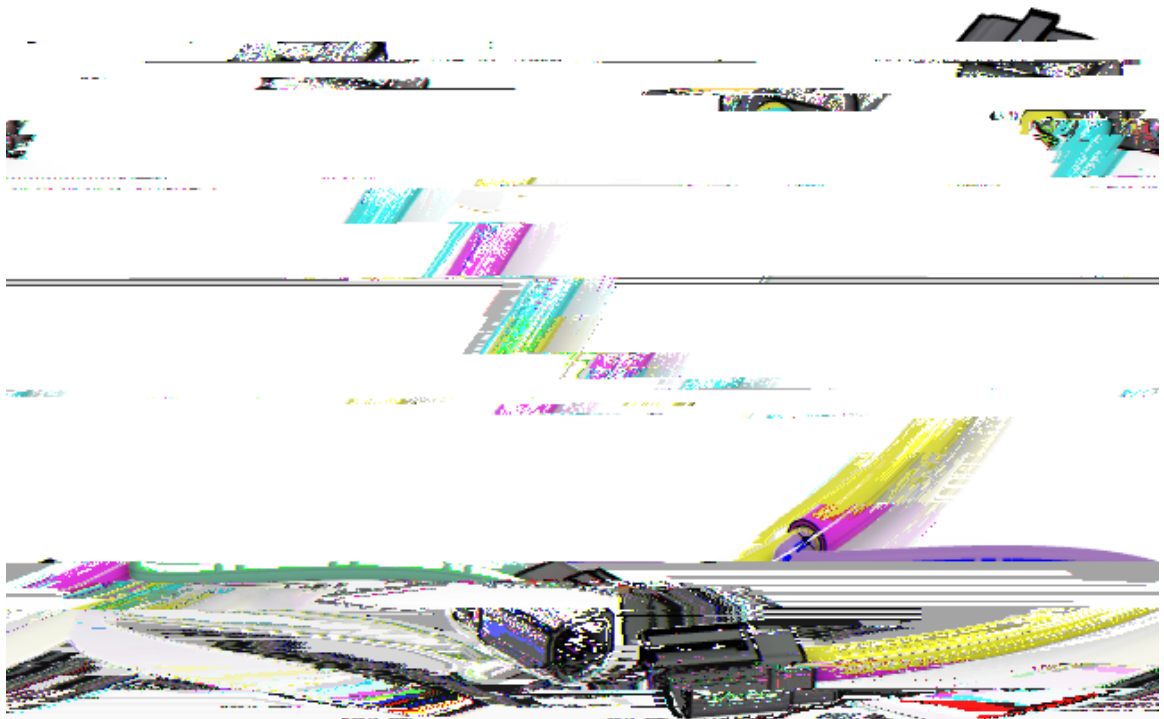

6HOH EXH WKRIQ WR UHWXULQ DOR W KIW L Q Q H Z W U N E H Q F K

6DYH DQG FORVH \RXU GRFXPHQW

2 S H Q ELEC090 - Branch Installation SUR GXJFW"uk o rng"dqz"vq"rww"vjg" yktg
jctpguu" {qw"lwuv"etgcygf"kpvc0"Kv"ujqwnf"cr rget"cu"ujqyp0



:LWK WKH ULJKW PRXVHEELEC090N Branch Installation VS URQGWIKW
IURP WKH VSHFLILFD Insert Existing Product DQG VHOHFW

6 HDU FK IRU D ELEC090 Multi-Branchable SUR GXJFW"cr rget"cu
ujqyp0

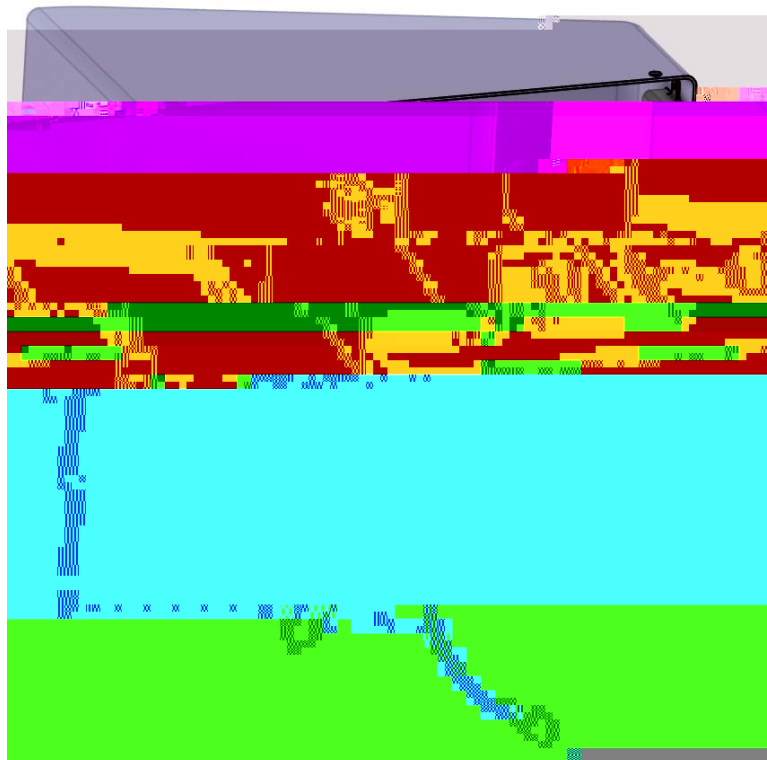

Cv"vjku"rqkpv."{qw"ctg"tgcf{"vq"dgi"kp" ocmkpi"vjg"pgeguuct{"eqppgev"kpqu"vq"kpucnm"vjg"jctpguu
kp"vq"vjg"dqz0"

,I QRW DOUHDG\ VKKH(UHFWZLWFDKOW'R'FWKpeg{Qw"zg
eqppgev"kp"i"vyq"nggevtkecn"eqppgev"qtu"vq"igvjgt."{qw"ecp"wug"vjg"eqppgev"fgxkegu"vq"qnu0"

6 HOHFW WKH **Connect Devices** LFRQ WKHQ VHOHFW WKH FRQQHFWRU
VHJP  Wjku"yknn"kp"fkcevg"y"jcv"eqppgev"qt{"qw"ctg"i"qkpi"vq"eqppgev"hktuv0"

6 HOHFW WKH SLQ FRQQHFWRU"RQ"WkH"Q"j"v
vykeg"kh"kv"ku"kp"xkuwcnk|cvkqp"oqfg0"

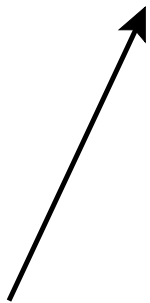

Vcmg"pqvg"qh"vjg"tguwnvki"yktg"dwpfngl"

Pqvkeg"vjg"ugi o gpv"urnk"nqecvkqp0""Ukpeg" {qw" fghkpgf"vjg"urnk" r qkp"vq"dg"8" kpejgu"htq o "vjg

6 HOH Connect Devices LFRQ DJDLQ WKHQ VHOHFW WKH FRQQH
VHJPHQW DQG WKH SLQ  RQVQVWU RQVQVWU RQVQVWU ULJKW
eqppgevqt0"

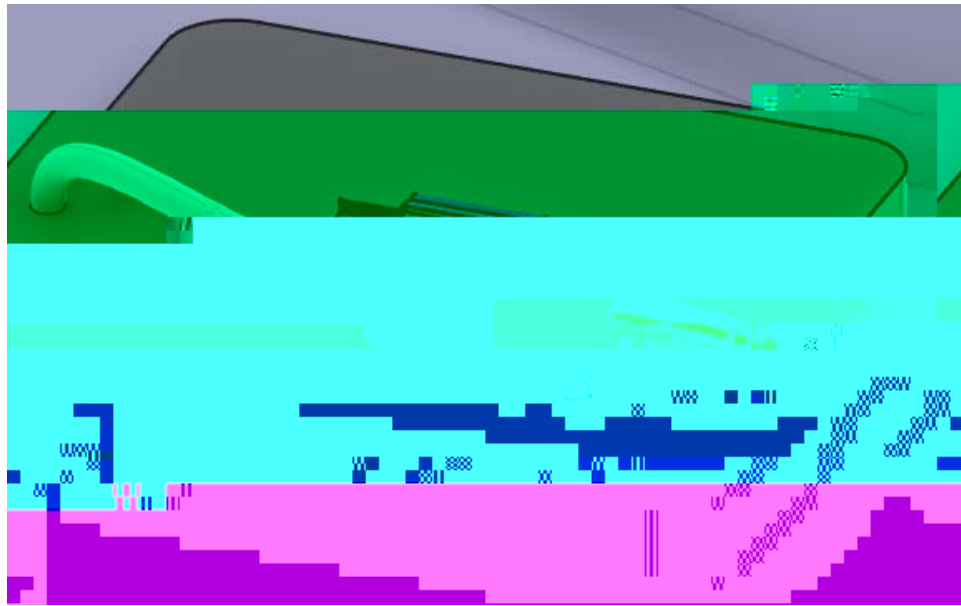

& RQQHFW WKH R  FROQHFW RUV

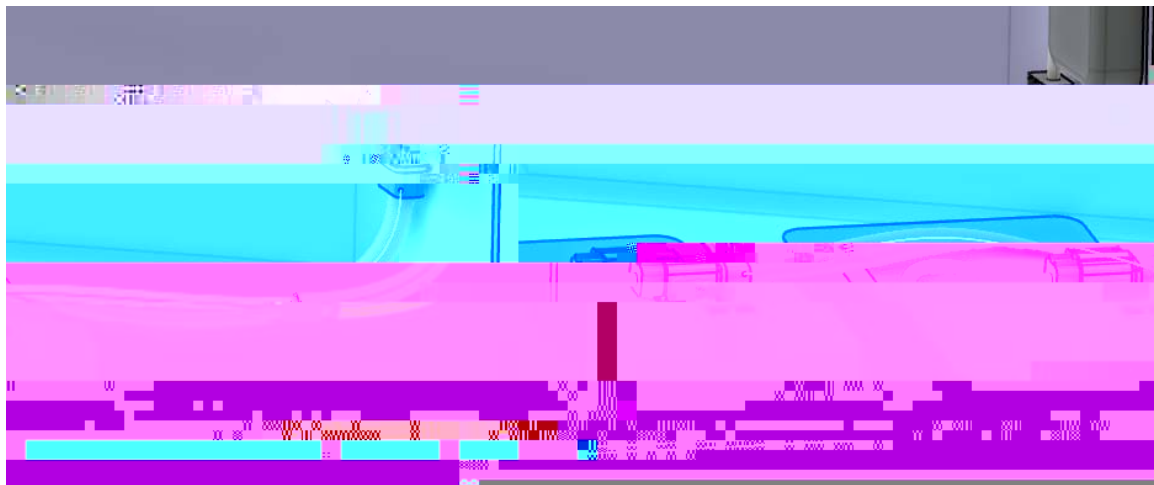

Pqvkeg"vjg"vykuvgf"dtepej0""Vjku"yknn"igv"hkzgf"cu">{qw"dgikp"cfkpi"uwr rqtvu"cpf"qvjgt"nkpmu
vq">{qwt"dtepejgu0"

6DYH DQG FORVH "\RXU GRFXPHQW

Electrical Manufacturing Preparation

Hncvvgpkpi"vjg"dwpfng"ku"i gpgtcnn{"vjg"hkpcn"uvgr"vq"cp{"fgxgnqr o gpv"qh"c"i gq o gvtkecn"dwpfng() Dghqtg"c"dwpfng"ecp"dg"o cpwhcevtgfg."kv"y knn"i gpgtcnn{"pggf"vq"dg"hncvvgpgf"hqt"fk o gpukqpu qp"yktg"ngpi vj."cu"y gnn"cu"hqt o "dqctf"fgxgnqr o gpv"cpf"eqppgevqt"ecnn"qvwu0""Vjgtg"ctg"chgy mg{"rqpvu"vq"mgrp"kp"okpf"y jgp"hncvvgpkpi" {qwt"i gq o gvtke"dwpfng0""Hktuv."vjg"hncvvgpgf i gq o gvtke"dwpfng"ku"ugrctcvg"htq o "vjg"dgpv"i gq o gvtke"dwpfng0""Vjku"cnny u"vjg"hncvvgpgf i gq o gvtke"dwpfng"vq"o ckpvckp"cuuqekcvkxv{"kp"fk o gpukqpu"cpf"i gq o gvt{"dww"pqv"kp"vjg"uj crg qh"vjg"dwpfng0""Vjg"ugeqp"vjki"vq"mgrp"kp"okpf"ku"vjcv"vjg"hncvvgpgf"fqew o gpv"ku"i gpgtcnn{ wugf"hqt"ftchkpi"cpf"HVC"o ctmwr"cpf"cppqvckqpu0""Cnvjqwi j"vjku"y knn"dg"vqwejgf"qp"jgtg. vjku"y knn"pqv"dg"vjg"hgewu"qh"vjku"ugevkqp0"

Formboard Creation

Vjg"hqt o dqctf"cpf"rtgrctg"nc{qvw"qrvkqpu"ctg"vjg"pgy guv"o gvjqfu"hqt"etgcvkpi"jctpguu hncvvgpkpi0""Vjku"ugevkqp"y knn"fg o qpvtcvg"vjg"rtqeguu0"

2 S H Q **EMEC340 - Flattening Orientation** G R F X P H U Q W f"crrgct"cu"ujqyp0

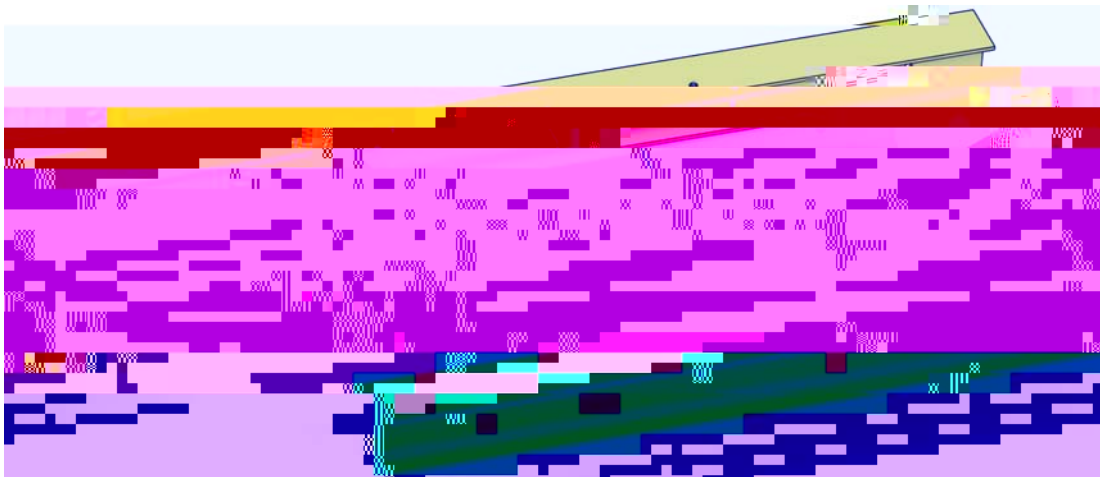

6 H O H **Formboard** L F  "Vjg"Formboard Process ykpfqy"crrgctu0

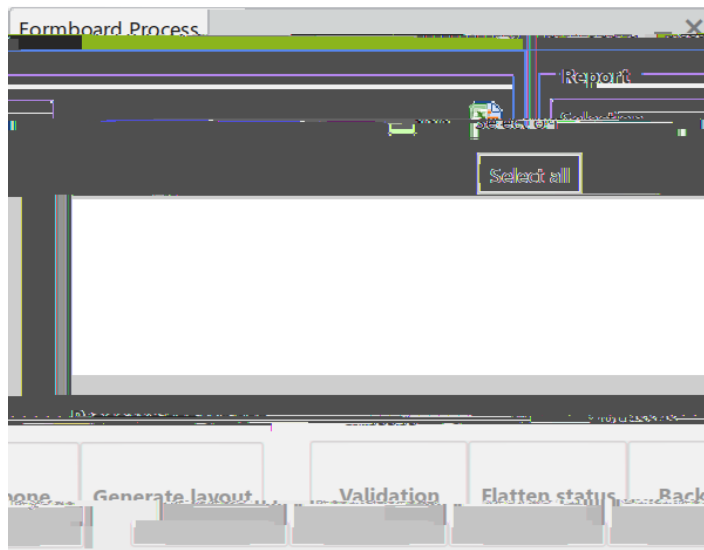

6 H O H ~~Electrical~~ **Electrical Geometry** L Q W K H W U H H W R G H I L Q M Z K D W Z L O
ujqwnf"errget"kp"vjg"ykpfaqy"cpf"kv"ujqwnf"jki jnki jv"kp"vjg"fkurnc{0

6 H O H ~~Validation~~ **HE X W Wg Rj Q** pguu"ujqwnf"jki jnki jv"itggp"cu"ujqyp0

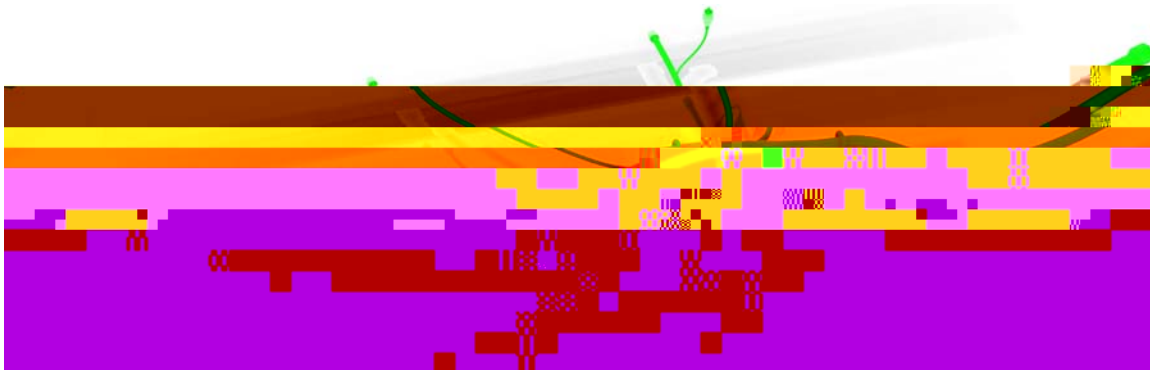

I tggp Urgekhkgu"vjg"dtcpej"ecp"dg"hncvvgpgf

[gmqy Urgekhkgu"vjg"dtcpej"ecppqv"dg"hncvvgpgf

Oci gpcv Urgekhkgu"vjg"dtcpej"ecp"dg"hncvvgpgf."dvw"y km"pqv"dg"uvtcki jvpgpf

Dnwg Urgekhkgu"vjg"dtcpej"ku"cntgcf{"hncvvgpgf

6 H O H ~~Attention~~ **HE X W W R Q** L Q W K H Z L j Q G R Z cp"itggp0

6 H O H ~~Backbone~~ **HE X W Wg Rj Q** p"dtcpej"ujqwnf"ejcpig"vq"rkpm"cpf"ujqwnf"jcxg"vjg
uvtv"cpf"gpf"ncdngf0

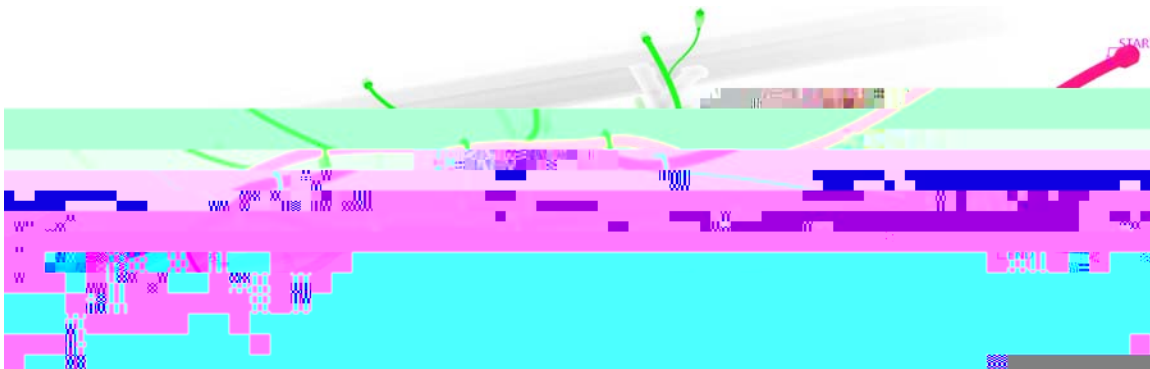

6 H O H G u n e r W e k a h o u t E X W W p y Q r t q f w e v " k u " e t g c v g f " k p " c " p g y " v c d 0 " " V j g
Formboard Process" y k p f q y " u j q w n f " c r r g c t " c u " u j q y p 0



& O R V F o r m b o a r d P r o c e s s Z L Q G R Z D Q G V Z L W F K W R K v W y d n h Q H Z S U R G
c r r g c t " c u " u j q y p 0

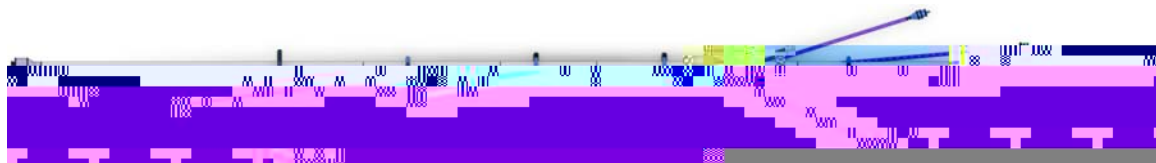

V j g " g p v k t g " j c t p g u u " y c u " d t q w i j v " q x g t " k p e n w f k p i " c p { " k p v g t p c n " g n g e v t k e c n " e q p p g e v q t u 0 " " P q v k e g " c
u g r c t c v g " r t q f w e v " y c u " e n u q " e t g c v g f " v j c v " k p e n w f g u " c p { " u w r r q t v u " v j c v " y g t g " w u g f " d { . " d w y " p q y
k p v g t p c n " v q " v j g " j c t p g u u 0 " " "

Prepare Layout

CATIA Electrical Harness Design

6HOHFW QH DU WKH HQG RI WKH VPD OO EUDQFK

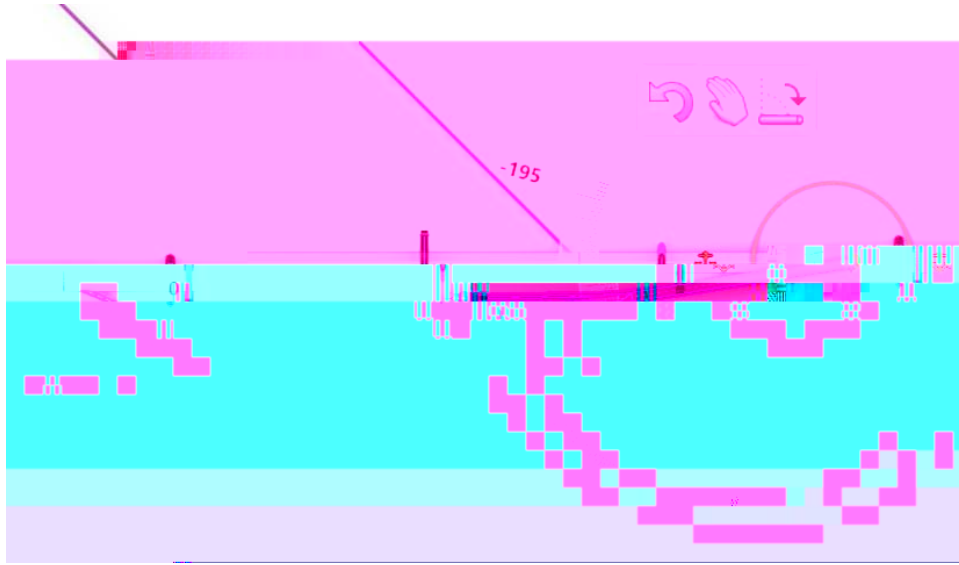

5RWDWH WKH EUDQFK WR

GHJUHHV DQG VHOHFW LQ VSI

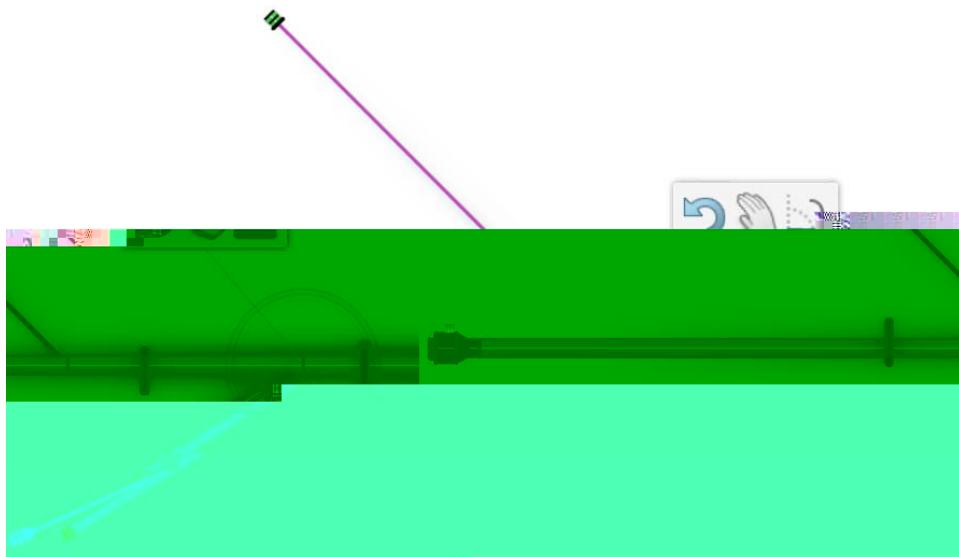

6HOHFW WKH HQG RI WKH VPD OO EUDQFK D QSG RVR W/DGLHQ J WU W
 GHJUHHV 6HOHFW "VQ" yknsD" F" Htczng" Vj" Qg" GkP" Qdpej0



6 HOH **Prepare Layout** LFRQ WR FRPSOHWF "Kjg" j Rpgu Q DDQLSXODWLRQ
ujqwnf"crrgct"cu"ujqyp0

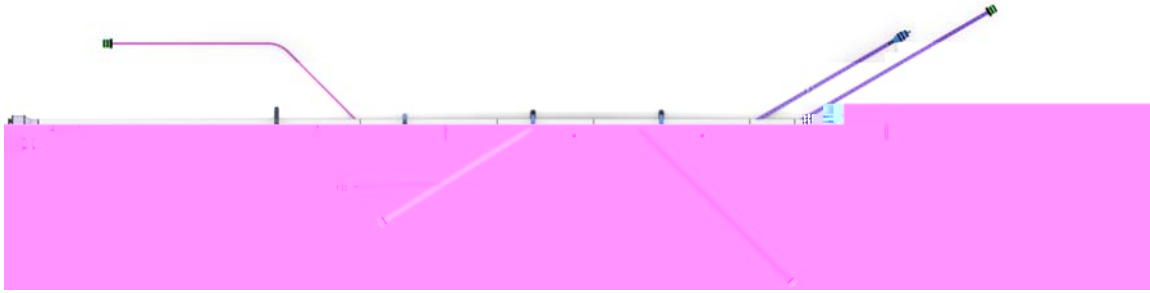

5HQDPH WKH WRS OHYHO SURGXFW DQG WKH VXE DVVHPEO



6DYH WKH **EXPLODE** "Bng" QW jg"pgzv"gzgtekug0